

# Troubleshooting and Maintenance Manual



*Jacobs®*

Jacobs®, Jake Brake®, Auto-Lash® and Power-Lash® are registered trademarks of  
Jacobs Vehicle Equipment Company  
22 East Dudley Town Road  
Bloomfield CT 06002

---

# Table of Contents

## Section 1: Troubleshooting

Introduction .....	1
Safety Precautions .....	1
Engine Brake Part Replacement .....	1
Automatic Transmissions .....	1
<b>1.1 Electrical System .....</b>	<b>1.1</b>
Electric and Electronic Controls .....	1.1.1
Required Tools .....	1.1.1
Preliminary Electrical Checks .....	1.1.1
Clutch Switch .....	1.1.2
Fuel Pump Switch (Cummins PT Fuel Pump) .....	1.1.2
Diode Protection .....	1.1.2
Buffer Switch Adjustment .....	1.1.3
Fuel Pump Switch Adjustment – CAT .....	1.1.3
Foot Switch .....	1.1.4
Solenoid Valve .....	1.1.5
Troubleshooting: CAT PEEC Controls .....	1.1.7
Troubleshooting: DDEC II Electronic Controls .....	1.1.11
Troubleshooting: Low Engine Speed Retarder Cut-off .....	1.1.17
Wiring Diagrams .....	1.1.21
<b>1.2 Hydraulic/Mechanical .....</b>	<b>1.2</b>
Theory of Operation .....	1.2.1
Operational Sequence .....	1.2.1
Brake Housings and Rocker Groups Inspection .....	1.2.2
Engine Brake Housing Oil Pressure Check .....	1.2.2
Preliminary Checks .....	1.2.4
Control Valve Component Inspection .....	1.2.4
Engine Brake Housing Oil Pressure Requirements .....	1.2.5
<b>1.3 General Problem Analysis .....</b>	<b>1.3</b>
Tools and Parts Available .....	1.3.1
General Problem Analysis .....	1.3.2
<b>1.4 Engine Brakes for Cummins Engines .....</b>	<b>1.4</b>
Two-valve Design .....	1.4.1
Current Production Models .....	1.4.1
Special Features .....	1.4.2
Operation .....	1.4.2
Single-valve Design .....	1.4.3
Special Features .....	1.4.4

<b>1.5 Engine Brakes for Caterpillar Engines.....</b>	<b>1.5</b>
Model 346D .....	1.5.1
Special Features .....	1.5.1
Model 349A .....	1.5.2
Exhaust Blowdown .....	1.5.3
Slave Piston Adjustment .....	1.5.4
Trigger Valve Adjustment .....	1.5.4
Models 317D/317E .....	1.5.7
Power-Lash® .....	1.5.7
Housing Assembly Differences .....	1.5.8
Slave Piston Adjustment .....	1.5.9
Mounting Studs .....	1.5.9
Models C336/336A .....	1.5.10
Exhaust Valve Stem Caps .....	1.5.10
Slave Piston Clearance Settings .....	1.5.11
<b>1.6 Engine Brakes for Detroit Diesel Engines.....</b>	<b>1.6</b>
General Application Information .....	1.6.1
Adjustment of Engine Brake Slave Pistons .....	1.6.1
Special Features/Procedures .....	1.6.2
Fuel Pipe Installation .....	1.6.3
Fast Idle Buffer Switch .....	1.6.4
Models 760/760A/765 .....	1.6.7
Engine Identification .....	1.6.7
Slave Piston Adjustment .....	1.6.7
Housing Mounting Bolts .....	1.6.7
Ball Check Valve (Model 760 Only) .....	1.6.8
<b>1.7 Engine Brakes for Mack Engines .....</b>	<b>1.7</b>
General Application Information .....	1.7.1
Special Features/Procedures .....	1.7.1
Valve Stem Caps .....	1.7.1
Slave Piston Adjusting Screw .....	1.7.2
Oil Supply Screw (675/675A) .....	1.7.2
Slave Piston Adjustment .....	1.7.3
Exhaust Valve Yoke Replacement .....	1.7.3

## Section 2: Preventive Maintenance

Introduction .....	1
Recommended Preventive Maintenance Schedule .....	1
<b>2.1 Inspection Criteria .....</b>	<b>2.1</b>
Safety Valve Screw Assembly Inspection .....	2.1.1
Exhaust Crosshead/Bridge or Valve Stem Cap Inspection .....	2.1.1
Master Piston Inspection .....	2.1.2
Injector/Exhaust Rocker Arm Adjusting Screw Inspection .....	2.1.2
Slave Piston Inspection .....	2.1.3
Crosshead Screw and Pin Assembly Inspection .....	2.1.3
Slave Piston Adjusting Screws Inspection .....	2.1.4
Control Valve Inspection .....	2.1.4

---

# Section 1: Troubleshooting

## Introduction

Jacobs Engine Brakes are manufactured to the highest standards of quality. Care has been taken in every step of manufacture to produce a product capable of functioning reliably at normal and peak performance. This manual has been prepared to assist the operator and mechanic in correct maintenance and troubleshooting procedures that ensure satisfactory engine brake operation.

Troubleshooting, as discussed in Section 1, is a step-by-step procedure to determine the cause of malfunctions and problems interfering with satisfactory engine brake operation. Malfunctions and/or problems occurring in the Jake Brake can be classified as Electrical or Hydraulic/Mechanical in nature. To effectively troubleshoot the engine brake system, the mechanic must have a working knowledge of these two systems.

Section 1 also describes the basic operation of engine brakes and components, and recommends procedures to follow when troubleshooting.

Proper maintenance, as discussed in Section 2, will assure maximum engine brake performance and a reliable service life.

## Safety Precautions

The following symbols in this manual signal potentially dangerous conditions to the mechanic or equipment. Read this manual carefully and know when these conditions can exist. Take necessary steps to protect personnel as well as equipment.



THIS SYMBOL WARNS OF POSSIBLE PERSONAL INJURY.

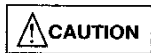

THIS SYMBOL REFERS TO POSSIBLE EQUIPMENT DAMAGE.

Do not work on this equipment when mentally or physically fatigued. Always wear eye protection.

Fuels, electrical equipment, exhaust gases and moving parts present potential hazards that could result in personal injury. Take care when installing an engine brake. Always use correct tools and proper procedures.

The Jake Brake is a vehicle slowing device, not a vehicle stopping device. It is not a substitute for the service braking system. The vehicle's service brakes must be used to bring the vehicle to a complete stop.

Jacobs Service Letters should be consulted for additional applications and updated information.

## Engine Brake Part Replacement

Each engine brake housing assembly has an identification tag showing model number and part number. A packaged housing assembly has a different part number than the housing assembly inside the package. When ordering a replacement housing assembly, the packaged housing assembly part number must be used.

The Installation Manual should be used in conjunction with the Jacobs Parts Manual when additional replacement part information is required. The Parts Manual can be obtained from your Jacobs distributor.

For more information on driving with the Jake Brake, read your Jacobs Driver Manual.

## Automatic Transmissions

For vehicles with automatic transmission, refer to Jacobs Service Publications or contact your nearest distributor.

---

# 1.1 Electrical System

## Electric and Electronic Controls

Advancements in vehicle and engine controls have demanded changes to Jacobs Engine Brake control systems. New engine control systems include the following:

Caterpillar: PEEC	Cummins: CELECT
Detroit Diesel: DDEC	Mack: V-MAC

Section 1.1 Electrical System covers basic information and troubleshooting of electric and electronic control systems.

Electrical power to energize the Jake Brake should always come from a terminal on the vehicle ignition switch that is energized when the switch is turned "on". This circuit must be protected by a 10-amp fuse or circuit breaker. The circuit is then connected to the ON/OFF switch, clutch switch, fuel pump (buffer) switch, and then to the solenoid valves.

Refer to the wiring diagram for specific engine brake models being worked on.

NOTE:

A DIODE IS INCORPORATED IN THE SYSTEM AT THE FUEL PUMP (BUFFER) SWITCH. THE DIODE PREVENTS HIGH VOLTAGE SPIKES THAT OCCUR EACH TIME THE SOLENOIDS ARE DE-ENERGIZED. THIS PREVENTS INTERNAL DAMAGE TO THE SWITCHES.

## Required Tools

The following tools should be available to troubleshoot electrical problems:

1. Volt/OHM/AMP meter (digital readout)
2. Continuity tester
3. Test light

## Preliminary Electrical Checks

1. **Vehicle Electrical Power.** Using a voltmeter, check to see that the supply voltage is at least 12 - 14 VDC or 24 - 28 VDC. Verify that wiring follows the correct Jacobs Engine Brake wiring schematic.

If the truck is factory pre-wired and the power source is from a breaker panel, make sure the circuit breaker is correctly reset. Make certain power is not drawn from a source with an additional ON/OFF switch or power draw for other components.

2. **Jacobs' Switches.** Using a voltmeter, check the dash switch, clutch switch and throttle switch for a voltage drop across each switch with the switch closed. Replace the switch if a voltage drop is 0.4 VDC or greater.

Inspect switches for correct adjustment. Check the throttle and clutch return springs for correct adjustment and operation.

3. **Wiring.** Check for short circuit in the wiring. Replace any broken, brittle, chafed, scorched or melted wires. It is recommended that all under-hood or under-doghouse wiring be covered by Jacobs' Auto-Loom or similar good quality loom. Replace Jacobs in-line fuse (10 amps) if blown or reset circuit breaker if necessary..

The following procedures are recommended:

Wire-end terminals should be securely attached to wires. If not, replace terminal. Wire size should be no smaller than 16 gage.

Wire-end terminals should be attached tightly to space connectors. If not, remove and replace, or if necessary, re-crimp and reattach.

Harness wire or loom should be carefully routed and should not contact moving equipment such as throttle, clutch or transmission linkage.

Harness wire or loom should not contact high temperature engine components such as exhaust manifold or turbo housings.

Harness should be secured in place with tie-wraps at regular intervals.

## Clutch Switch

Adjust the switch by moving the switch along the mounting bracket. The actuator arm should be deflected 1.0 - 1.5" (25 - 38 mm), measured at the tip of the actuator, when the clutch pedal is in the up (clutch engaged) position.

Check installation by moving the clutch pedal. The switch should click from the open to closed position of the switch contacts in the free-play motion of the clutch pedal before actual clutch disengagement takes place.

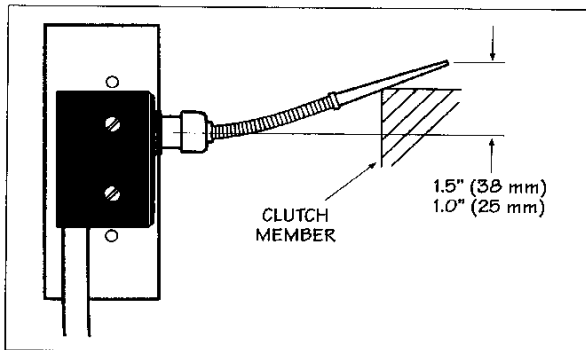
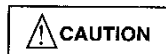

FIG. 1.1.1



EXCEEDING 1.5" DEFLECTION OF THE ACTUATOR ARM MAY CAUSE SWITCH DAMAGE, RESULTING IN ENGINE BRAKE MALFUNCTION.

## Fuel Pump Switch (Cummins PT Fuel Pump)

Move the throttle to the low idle position and insert a 0.05" (1.27 mm) feeler gage between the switch plunger and actuating lever (A, Fig. 1.1.2). Push the switch lever against the switch plunger until the plunger bottoms. Tighten the cap screw to 7 lb.-ft. (10 N·m).



AFTER INSTALLING THE ACTUATING ARM, CHECK THE FUEL PUMP THROTTLE SHAFT TO BE SURE THE THROTTLE PEDAL WILL MOVE THE SHAFT TO THE FULL FUEL POSITION. FAILURE TO DO SO MAY RESULT IN RESTRICTED ENGINE CONTROL. IF THE RESTRICTED MOVEMENT IS FOUND, CORRECT THE PROBLEM AND READJUST THE ACTUATING LEVER.

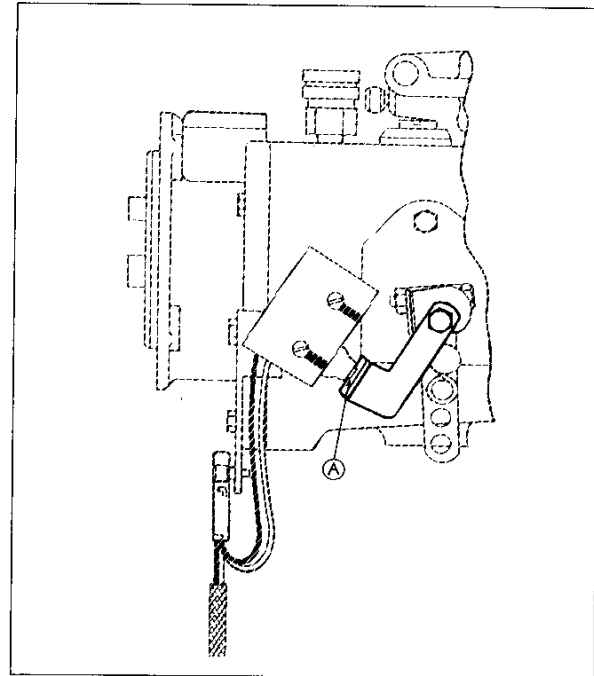

FIG. 1.1.2

## Diode Protection

NOTE:

SWITCH CONTACTS ARE PROTECTED AGAINST ARCING BY A SMALL DIODE CONNECTED BETWEEN THE LOAD SIDE SWITCH TERMINAL AND GROUND. THE ENGINE BRAKE MUST BE CONNECTED TO THE LOAD SIDE TERMINAL. IF THE VEHICLE HAS A POSITIVE GROUND ELECTRICAL SYSTEM, REVERSE THE DIRECTION OF THE DIODE (FIG. 1.1.3).

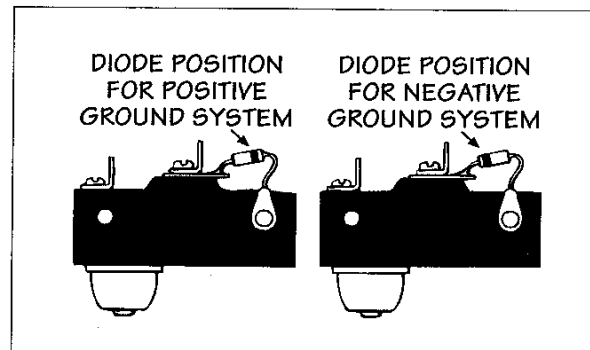

FIG. 1.1.3

# Buffer Switch Adjustment

## Buffer Switch - Detroit Diesel

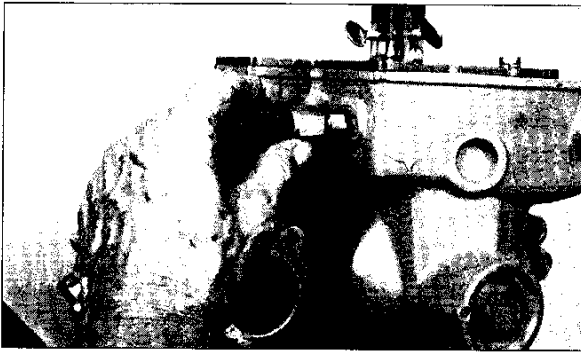

FIG. 1.1.4

1. Start the engine and allow to warm up. Record the idle RPM and maximum no load RPM.
2. With the idle speed set, adjust the buffer switch as follows:
  - a. Turn the buffer switch in until it contacts the connecting link as lightly as possible and eliminates engine roll (Fig. 1.1.4).

**NOTE:**

ENGINE IDLE SPEED WITH THE BUFFER SWITCH MUST NOT INCREASE MORE THAN 15 RPM FROM THE READING RECORDED IN STEP 1.

- b. Hold switch in this position and tighten locknut.

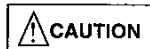

DO NOT TIGHTEN LOCKNUT MORE THAN 60 LB.-IN. (7 N·M). SWITCH FAILURE WILL RESULT FROM OVER-TORQUING.

- c. Check maximum no-load speed. If the increase is more than 25 RPM from the reading recorded in Step 1, back off buffer switch until increase is less than 25 RPM.
3. Shut down engine.

4. Early style buffer switches are polarity sensitive. Attach **NEGATIVE** lead (load side) to tin-plated terminal and the **POSITIVE** lead (power side) to the brass-colored terminal of the switch.
5. Current style buffer switches include a two-diode system for switch protection. The two-diode type switch is not polarity sensitive and electrical connections can be made to either terminal (see Fig. 1.1.5). This switch must only be used with negative ground systems.

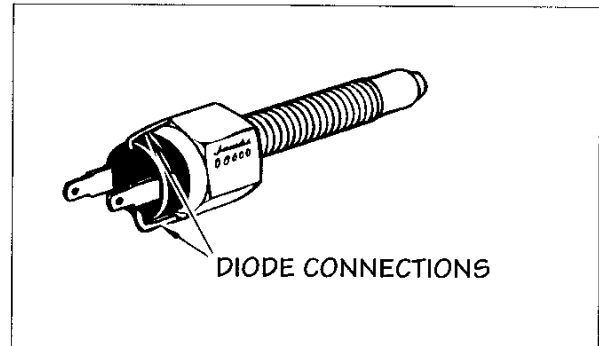

FIG. 1.1.5

## Fuel Pump Switch Adjustment - CAT

1. Start engine and check low idle RPM. Disconnect the throttle linkage and adjust the idle per Caterpillar specification by turning the switch clockwise to increase and counterclockwise to decrease engine RPM (Fig. 1.1.6).

### Fuel Pump Switch - Caterpillar 3406

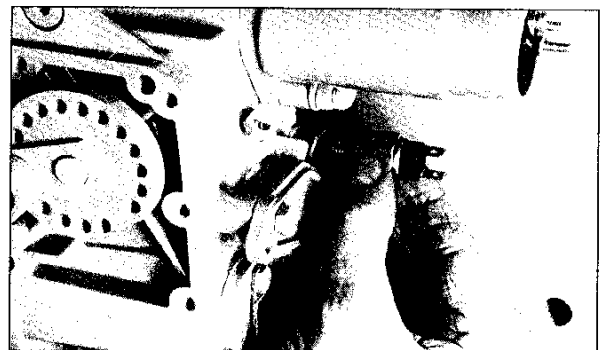
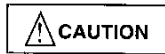

FIG. 1.1.6

2. When proper RPM is set, advance the throttle lever to increase engine speed and then return to idle. Check to be sure the idle RPM setting did not change. Readjust if necessary.
3. Hold the Jacobs switch and tighten locknut to 5 lb.-ft. (7 N·m). Reconnect throttle linkage.

If the fuel pump switch has a letter "D" or lower suffix after the part number, this switch is polarity sensitive. Connect the white wire from the engine harness to the silver terminal. Connect the orange wire from the engine harness to the brass (load side) contact. This ensures diode protection of the switches.

If the fuel pump switch has a letter "E" or greater suffix after the part number, harness wires can be connected to either switch terminal. These switches have two diodes for protection and are not polarity sensitive. This switch can only be used with negative ground systems.



CHECK TO BE SURE THAT THE GOVERNOR OPERATING LEVER MOVES FREELY FROM LOW IDLE TO HIGH IDLE POSITION AND RELEASES WITHOUT BINDING.

## Foot Switch

Optional Jacobs Foot Switch provides added driver convenience and control. Jacobs offers three different systems for engine brake control. Besides the standard semi-automatic system used with Caterpillar, Cummins and Mack engines, the customer now has the choice of two added options: fully automatic control with a "low speed" shut-off or fully manual control with a "foot switch".

The foot switch is installed on the cab floor within easy reach of the operator's left foot. After installation, light foot pressure on the top plate is all that is needed to operate the Jake Brake. The throttle switch, or buffer switch, remains in the system to ensure that fueling and engine braking do not occur at the same time.

### NOTE:

ENGINES WITH ELECTRONIC CONTROLS (NO FUEL PUMP SWITCH): CONNECT THE WIRES FROM THE FOOT SWITCH TO THE WIRE CONNECTING THE 12-VOLT (OR 24-VOLT) POWER TO THE DASHBOARD ON/OFF SWITCH.

Foot Switch Diagram

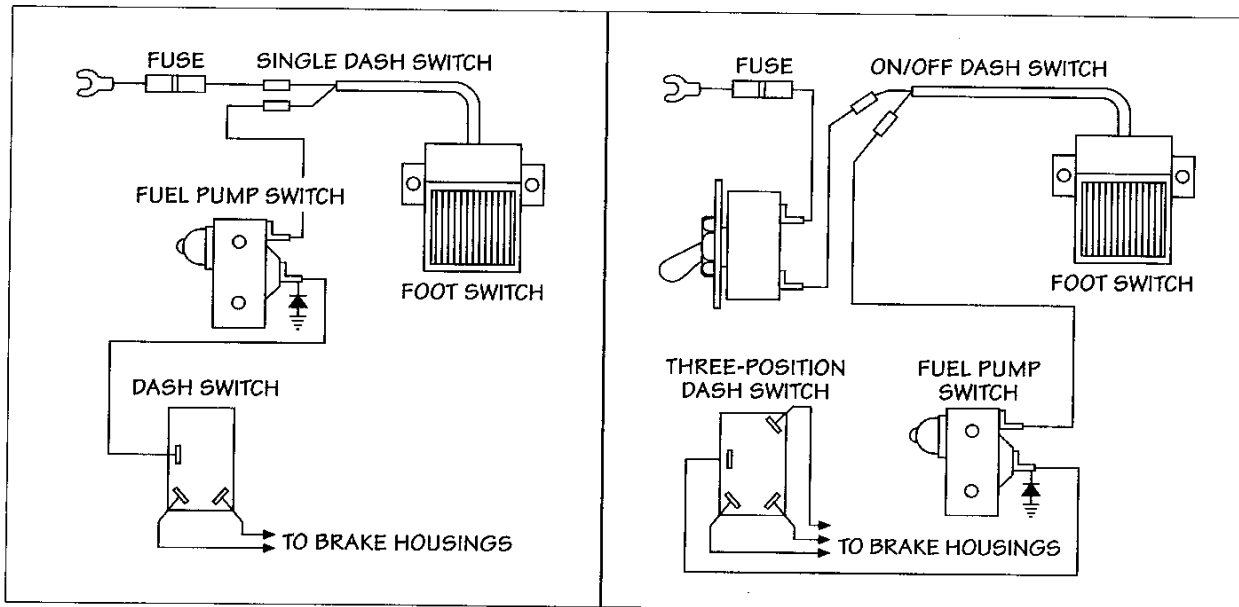

FIG. 1.1.7



# Solenoid Valve

The Solenoid Valve cannot be overhauled or repaired in the field. If any problem other than seal ring-related exists, the Solenoid Valve must be replaced.

## Operation Check

The best way to examine a solenoid valve coil for correct operation is with a volt/amp/ohm meter and then compare the readings for each solenoid with the proper specifications. If the proper meters are not available, a secondary check of proper solenoid valve operation can be made as follows:



DO NOT TOUCH THE ELECTRICAL CONNECTION WHEN A SOLENOID IS ENERGIZED. ELECTRICAL SHOCK COULD RESULT.

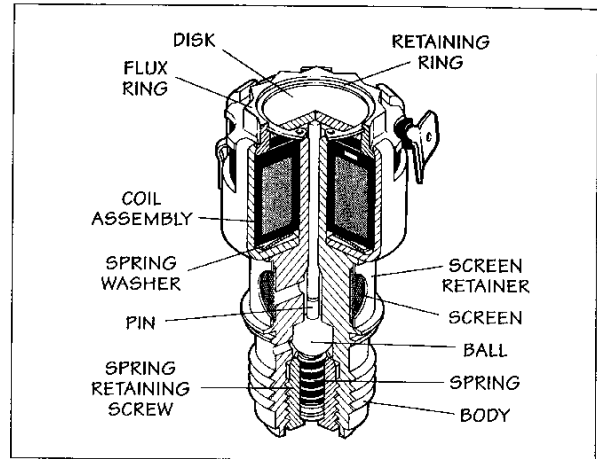

FIG. 1.1.8

1. Apply a 12-volt (or 24-volt) source to the solenoid electrical terminal.
2. When electrical power is supplied, make sure each solenoid valve cap depresses. If the cap does not depress, replace the solenoid.

P/N	VOLTAGE	RESISTANCE (OHMS)		CURRENT DRAW (AMPS)		PULL IN VOLTAGE (MINIMUM)	
		COLD	HOT	COLD	HOT	COLD	HOT
016440*	12 VDC	9.62 to 10.75	11.8 to 14.3	1.12 to 1.23	0.84 to 1.02	8.0	8.5
016441*	24 VDC	31.5 to 38.5	38.2 to 50.0	0.62 to 0.69	0.47 to 0.55	17.0	21
019650*	12 VDC D/L	9.75 to 10.75	11.8 to 14.3	1.12 to 1.23	0.84 to 1.02	8.0	8.5
016442*	24 VDC D/L	31.5 to 38.5	38.2 to 50.0	0.69 to 0.62	0.47 to 0.55	17.0	21
020239*	12 VDC	9.0 to 10.0	11.5 to 14.0	1.0 to 1.2	0.8 to 1.0	8.0 to 9.0	10.0 to 11.0
018674	12 VDC	9.5 to 10.5	11.5 to 14.0	1.15 to 1.25	0.86 to 1.04	9.5	11.9 to 12.7
013472*	24 VDC SCREW	34.9 to 38.7	43.3 to 51.3	0.62 to 0.69	0.47 to 0.55	18.0	22 to 24
003784, 004205, 003433, 002689	12 VDC	19.8 to 22.0	24.0 to 29.5	0.54 to 0.61	0.4 to 0.5	9.0	9.8 to 12.1
003784, 004205, 003433, 002689	24 VDC	19.8 to 22.0	24.0 to 29.5	1.08 to 1.22	0.8 to 1.0	9.0	9.8 to 12.1

\* Current Production Solenoid Valves  
D/L Dual Lead

FIG. 1.1.9

# Jacobs Models 346 B/C/D with Caterpillar PEEC\* Controls

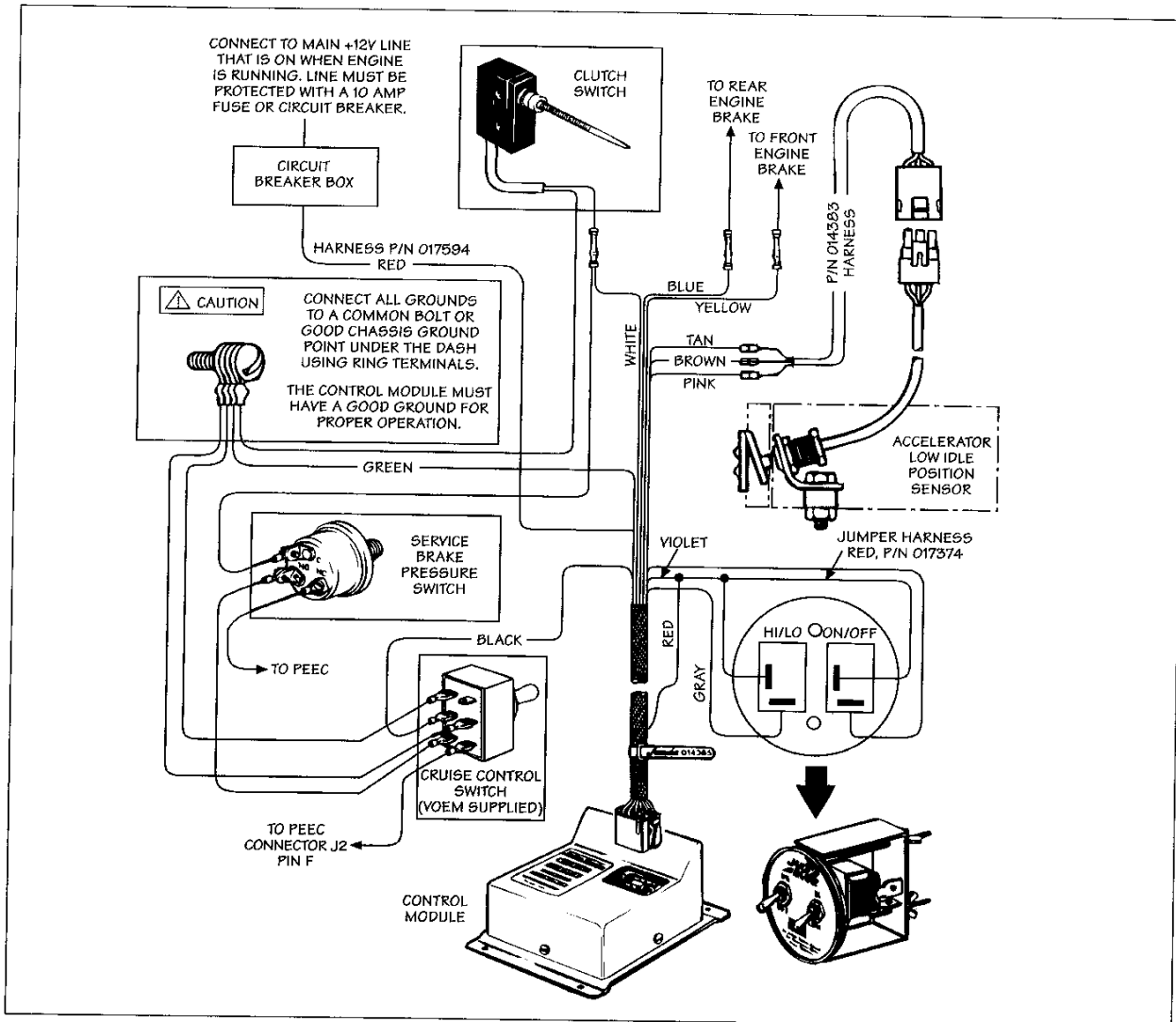

FIG. 1.1.10

\* Information on Caterpillar electronics (PEEC III) applications is not covered here and will be covered in separate documents.

# Troubleshooting: CAT PEEC Controls

## Problem: Engine Brake is Inoperable

**Probable Cause: No electrical power.**

**Correction:** Connect VOM positive (+) probe to common (lower) terminal of ON/OFF switch and negative (-) probe to ground (Fig. 1.1.11). With ignition switch on, VOM should read +12 volts. If not, check circuit breaker or fuse and wiring to switch and repair/replace as needed.

**Probable Cause: Dash switch(es) inoperative.**

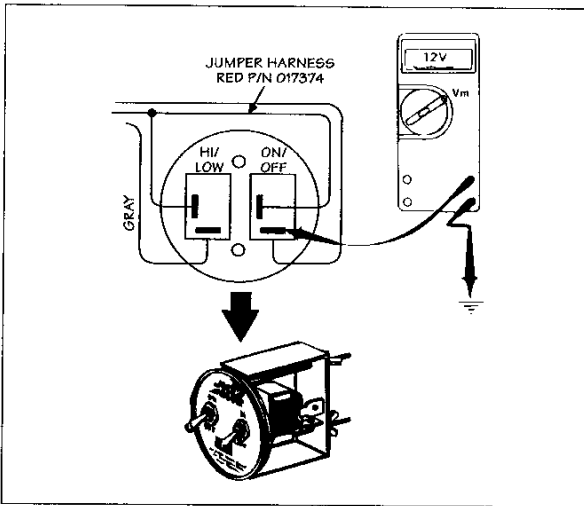

FIG. 1.1.11

**Correction:**

- A. Connect positive (+) probe of VOM to center terminal of ON/OFF switch and negative (-) probe to ground. With system energized and switch off, reading should be 0 volts. With switch on, reading should be 12 volts. If these readings are not obtained, replace ON/OFF switch.
- B. Connect positive (+) probe to center terminal of HI/LO switch and negative (-) probe to ground. With ON/OFF switch on and HI/LO switch in lo position, reading should be 12 volts. If not, check switch jumper wire and connections and repair/replace as needed.
- C. Connect positive (+) probe to lower terminal of HI/LO switch and negative (-) probe to ground. With HI/LO switch in lo position and ON/OFF switch on, reading should be 9 volts. With HI/LO switch in HI position, reading should be 12 volts. If these readings are not obtained, replace HI/LO switch.

**Probable Cause: Control module defective.**

**Correction:** De-energize the system and disconnect the harness, P/N 014383, from the ALIPS harness. Using the three clip leads, reconnect the brown, tan and pink wires. Connect the positive (+) probe to the tan wire and the negative (-) probe to the brown wire (Fig.1.1.12). With the system energized and clutch engaged (pedal up), reading should be 5 volts. If not, replace the control module.

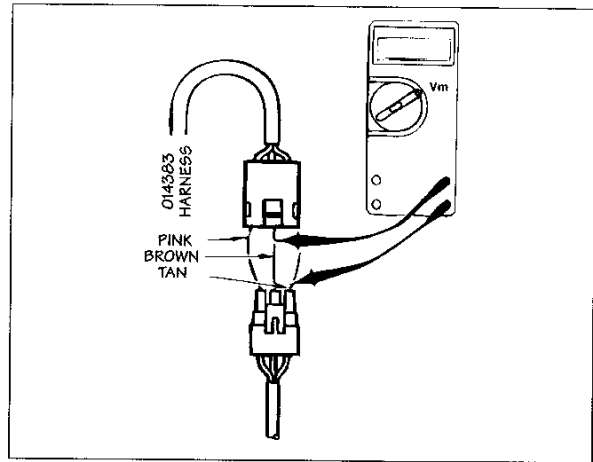

FIG. 1.1.12

**Probable Cause: ALIPS sensor inoperative.**

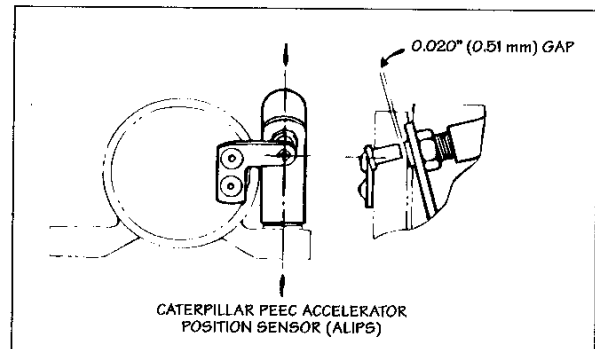

FIG. 1.1.13

**Correction:** If the previous reading was 5 volts, connect the positive (+) probe to the pink wire and the negative (-) probe to the brown wire. With the accelerator in the low idle position, the VOM should read 0 volts. If the reading is not 0 volts, the clearance between the magnet and sensor may be too large or the magnet may not be in line with the sensor. If necessary, realign the magnet and sensor and readjust the clearance to 0.02" (0.51 mm) (Fig. 1.1.13). If the volt meter still does not read 0 volts, replace the sensor assembly.

With the accelerator depressed, the reading should be 5 volts. If not, replace the ALIPS sensor assembly.

If the ALIPS sensor assembly functions properly, remove the clip leads and reconnect the harness.

**Probable Cause: Clutch switch inoperative.**

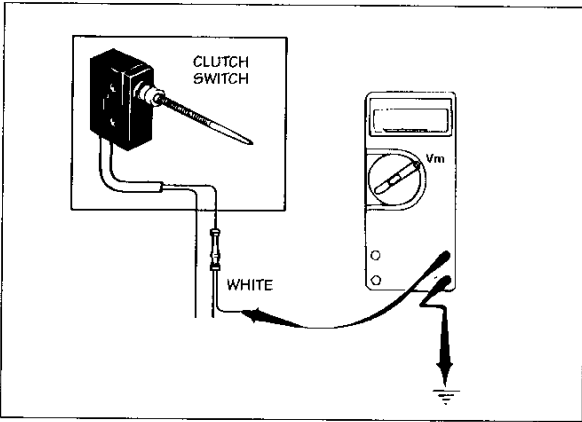

FIG. 1.1.14

**Correction:** Connect the negative (-) probe to the common ground point and the positive (+) probe to the white lead in the main harness (Fig. 1.1.14). Energize the system. With the clutch engaged (pedal up), VOM should cause a reading of 5 volts. If these readings are not obtained, check adjustment of clutch switch. Switch should actuate in the top travel portion of the pedal. Readjust if necessary.

If these checks are not OK, disconnect the wires at the clutch switch. Check continuity between the switch terminals. There should be 0 ohms resistance with the switch activated (contacts closed) and infinite resistance with the switch relaxed (contacts open). If these conditions do not exist, replace switch.

**Probable Cause: Service brake pressure switch inoperative.**

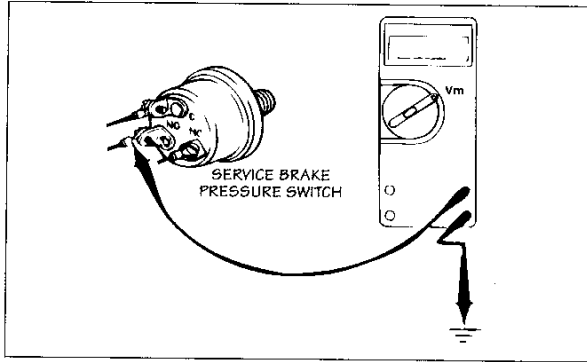

FIG. 1.1.15

**Correction:** Connect the positive (+) probe of the VOM to the normally open (NO) contact of the brake pressure switch and the negative (-) probe to ground. With the system activated, sufficient air pressure to activate the brake pressure switch, cruise control switch on, and clutch pedal up, the volt meter should read 5 volts (Fig. 1.1.15). With the service brake pedal depressed, the volt meter should read 0 volts. If these readings are not obtained, replace the service brake pressure switch.

**Probable Cause: Control module inoperative.**

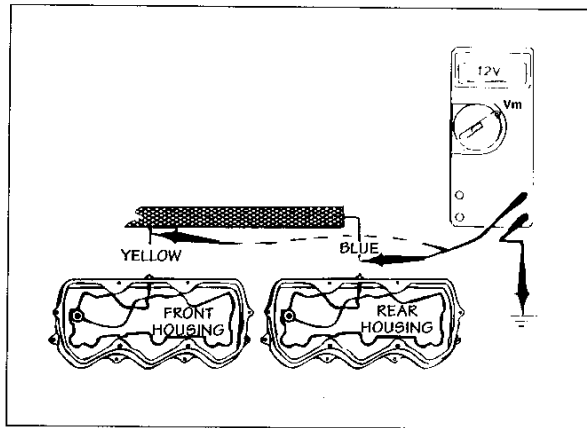

FIG. 1.1.16

**Correction:** If all of the above procedures do not locate the problem, disconnect the wire harness at the engine brake spacers. Set the selector switch in HI, accelerator in low idle, cruise control switch off and clutch switch activated, both blue and yellow wires should read 12 volts (Fig. 1.1.16). Depressing the clutch should cause the voltage at each wire to drop to 0 volts. If these readings do not occur, replace the control module.

**Probable Cause: Solenoid Valve**

**Correction:** With the blue and yellow wires disconnected at the engine brake spacers, connect one probe of the VOM to the solenoid terminal and the other probe to ground at the solenoid body (Fig. 1.1.17).

Reading should be 9.75 to 10.75 Ohms for current solenoid valves, P/N 016640. For early style solenoid valves, P/N 004205, the resistance should be 19.8 to 22 Ohms. If not, replace the solenoid valve (see Fig. 1.1.9 on page 1.1.5).

If solenoid resistance is OK, check continuity of solenoid lead wires. No reading from solenoid to connection at spacer indicates an open circuit and wire must be replaced.

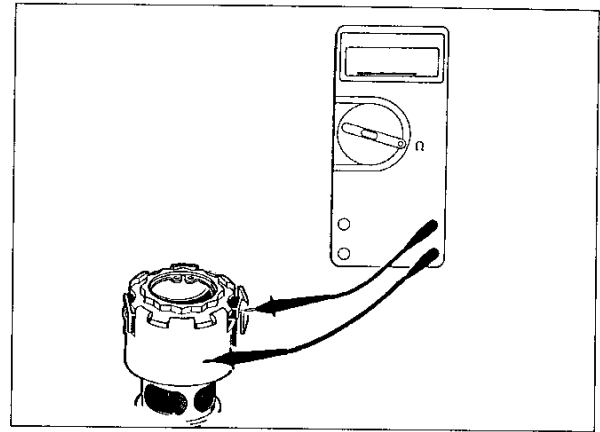
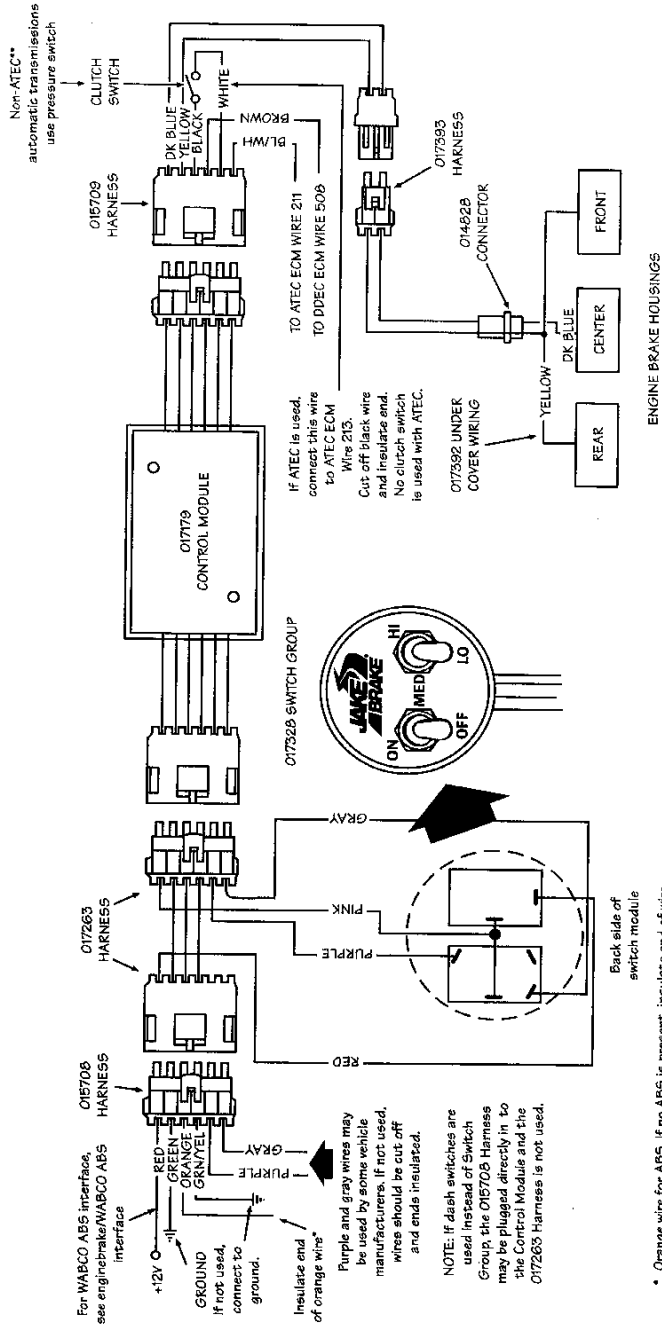

FIG. 1.1.17

# Wiring Diagram for DDC Engines

## MODELS 760, 760A AND 765 WIRING DIAGRAM DDEC SERIES II (3 MODE)

### RETROFIT/AFTERMARKET INSTALLATION



\* Orange wire for ABS. If no ABS is present, insulate end of wire.  
\*\* ATEC: Automatic Transmission Electronic Controlled



Jacobs® and Jake Brake® registered trademarks of  
Jacobs Vehicle Equipment Company  
22 East Dudley Town Road  
Bloomfield CT 06002

P/N 017372

© 1995 Jacobs Vehicle Equipment Company

3/95

FIG. 1.1.1B

---

# Troubleshooting: DDEC II Controls

## Models 760/760A/765 and 71/92A Engine Brakes

The Jacobs Electronic Control Module, P/N 017179, is a sealed electronic device and is not field serviceable. The Control Module can be operated using the standard dash toggle switches or the Jacobs Dash Switch Module, P/N 017328 or 017346. To test if this device requires replacement, follow the step-by-step procedures within the troubleshooting guide.

### Equipment Required for Testing:

Voltmeter with 20,000 Ohm/volt input impedance, minimum. Keep the voltmeter on the 20 VDC/div scale for the 12-volt control and 200 VDC/div scale for the 24-volt control for all test measurements.

#### NOTE:

THIS CONTROL CAN BE USED FOR 12- OR 24-VOLT OPERATIONS. USE +12/24 VOLTS WHEN REFERRING TO THE (+) BATTERY VOLTAGE. THIS GUIDE WILL MAKE REFERENCE TO A 12-VOLT OPERATION. ACTUAL BATTERY VOLTAGE MAY VARY UP TO 2 VOLTS.

If measuring the voltage at the solenoid valves, make sure that all wiring harnesses are connected. If the voltage at the output of the control is measured without the solenoid valves connected, both the BLUE and YELLOW wires will measure approximately +1 volt. These are internal voltages established by the control module when the output wires are disconnected.

## Operation Function

- The in-line switch module (if used) is connected to the power input side of the control. This is the harness with the RED and GREEN wires, P/N 015708.
- The ON/OFF power switch connects the RED wire to the +12 volt vehicle electrical system providing power to the control module.
- The PURPLE and GRAY inputs select which one of the DK BLUE or YELLOW outputs will be active. The (AUX LO) GRN/YEL, (AUX HI) ORANGE, (#508) BROWN, and (CLUTCH SWITCH) BLACK and WHITE inputs control when the DK BLUE and YELLOW will be active. To allow the outputs to be active, the following must be true:
  1. The clutch switch closed connecting the BLACK and WHITE wires together.
  2. The (AUX LO) GRN/YEL wire connected to ground (0 VDC).
  3. The (#508) BROWN wire switches to ground (0 VDC).
  4. The (AUX HI) ORANGE wire connected to ABS. If no ABS, end of wire should be insulated.

Before active troubleshooting is begun, check the integrity of all wiring and harness connections to verify that connections are tight and that wires are not pinched or have scraped insulation.

# Wiring Diagram for DDC Engines

## JAKE BRAKE® MODELS 71/92A WIRING DIAGRAM DDEC SERIES II (2 MODE)

CONTROL GROUP P/N 017363

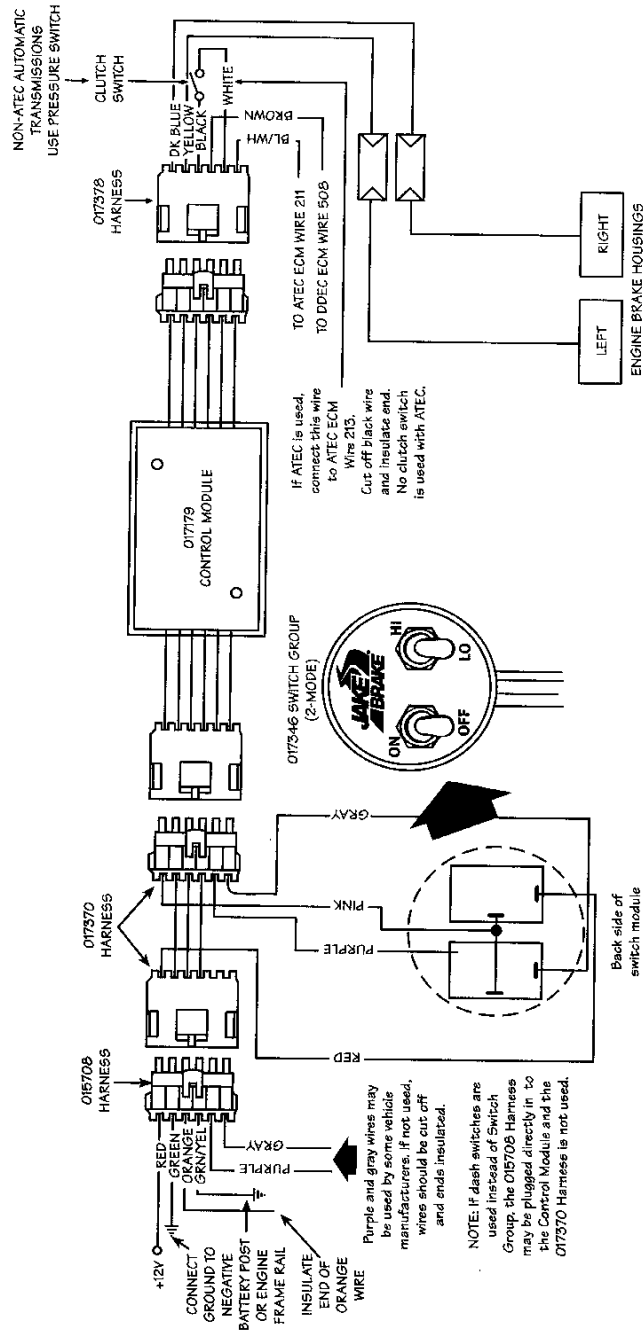

FIG. 1.1.19

**Jacobs®**

Jacobs® and Jake Brake® registered trademarks of  
Jacobs Vehicle Equipment Company  
22 East Dudley Town Road  
Bloomfield CT 06002

P/N 017371

© 1995 Jacobs Vehicle Equipment Company

4/95



# Problem: Engine Brake will not activate

**Probable Cause: Check supply voltage**

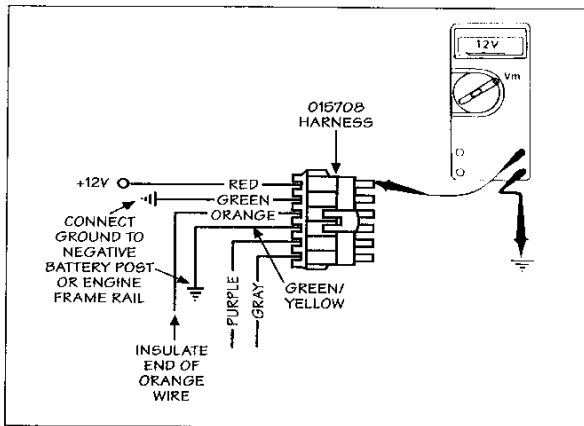

FIG. 1.1.20

**Correction:** With the ignition switch on, disconnect the P/N 015708 harness from the control module connector. Measure the voltage at the RED wire. Place the positive probe (+) of the voltmeter on the terminal of the RED wire and the negative probe (-) to ground. The voltmeter should read +12 VDC (Fig. 1.1.20). If this condition is not present, check that system is energized and check power supply.

**Probable Cause: Check switches and connections**

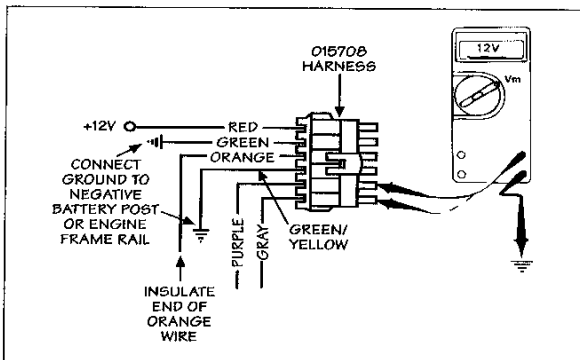

FIG. 1.1.21

**Correction:**

**Optional Selector Switch:** Disconnect P/N 015708 harness from control module. Measure voltage at both PURPLE and GRAY wires. With selector switch in HI position, both wires should read +12 VDC (Fig. 1.1.21). If this condition is not present, check power supply, connections and switches. Repair or replace as required.

**Jacobs Switch Group:** Disconnect P/N 017263 (017370) harness from Jacobs control module. Measure the voltage at the RED wire. The voltmeter should read +12 VDC when the main power supply is ON and 0 VDC with main power supply OFF (Fig. 1.1.22). If these conditions are not present, check power supply and connections.

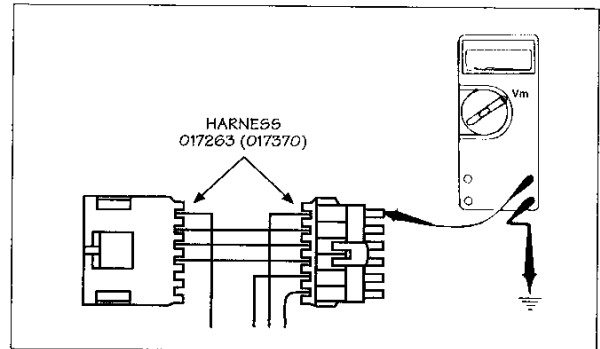

FIG. 1.1.22

(Fig. 1.1.23) With main power supply ON and selector switch in LO, the PURPLE wire should read +12 VDC and GRAY wire 0 VDC. With selector switch in MED position, GRAY wire should measure +12 VDC; PURPLE wire 0 VDC. With selector in HI position, both PURPLE and GRAY wires should measure +12 VDC. If these conditions are not present, check connections, check wiring schematic for proper position of wires to switch and/or replace switch.

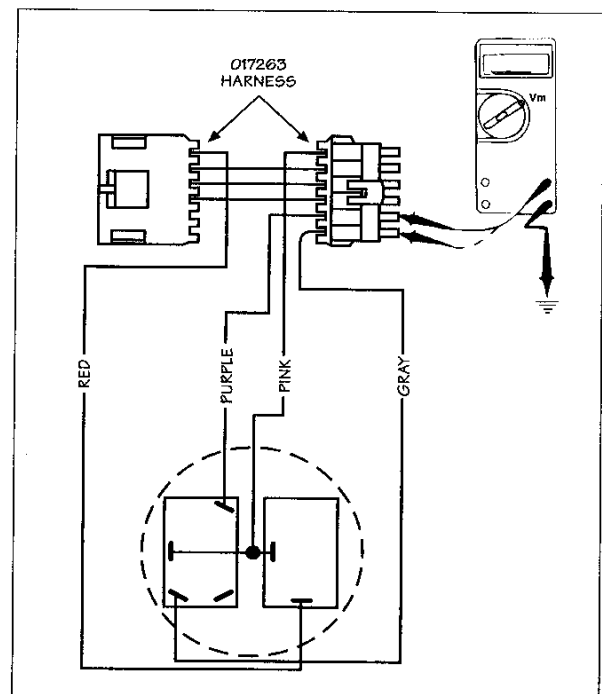

FIG. 1.1.23

**Probable Cause: Check clutch switch.**

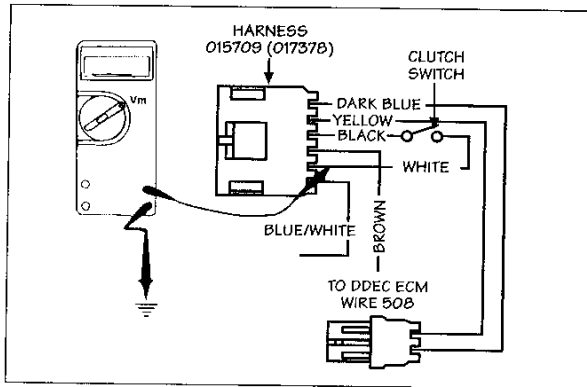

FIG. 1.1.24

**Correction:** With the P/N 015709 (017378) harness connected to the control module, measure the voltage at the terminal of the WHITE wire. With the clutch engaged (pedal not depressed), a reading of 0 VDC should be measured. With the clutch disengaged (pedal depressed) a reading of +5 VDC +/- 0.5 VDC should be measured (Fig. 1.1.24). If this condition does not exist, check continuity of clutch switch and BLACK and WHITE wires.

**Probable Cause: Check engine brake enable signal.**

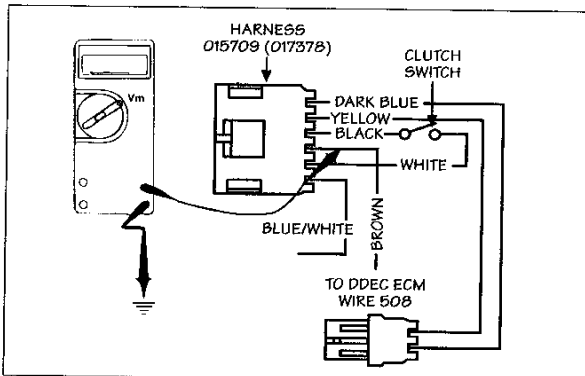

FIG. 1.1.25

**Correction:** Disconnect 015709 (017378) harness from 017179 module. Start the engine. Turn the engine brake switch OFF. Place the positive probe of the voltmeter at the terminal of the BROWN wire and the negative probe on ground (Fig. 1.1.25). Increase engine RPM to rated engine speed. The voltmeter should measure +12 VDC. Release throttle; voltage should drop to 0 VDC. When the engine reaches idle, the voltage should again read +12 VDC. If the voltage does not change, check connections and wiring. If problem continues, have the engine ECM checked.

**Probable Cause: Check output.**

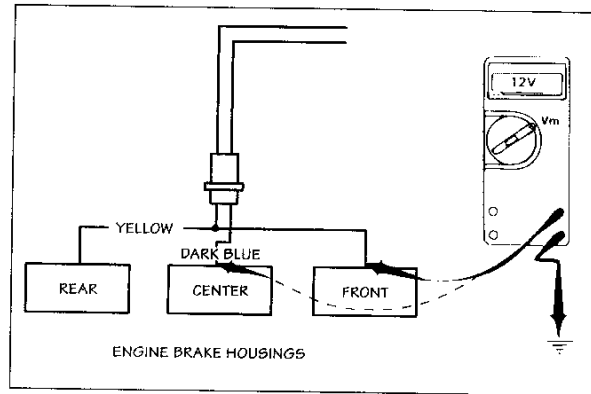

FIG. 1.1.26

**Correction:** Inspect DK BLUE and YELLOW wires leading to solenoid valve connectors. Check for loose contacts, pinched wires or scraped insulation. Start the engine, turn the engine brake switch ON and select HI. Advance the throttle to rated speed and then release the throttle. Voltage at both YELLOW and DK BLUE wires should measure +12 VDC (Fig. 1.1.26).

**NOTE:**

WHEN MEASURING VOLTAGE, CHECK THAT ALL HARNESS CONNECTIONS ARE TIGHT. IF THE VOLTAGE IS MEASURED WITH THE HARNESS FROM THE SOLENOID LOOSE OR DISCONNECTED, BOTH THE DK BLUE AND YELLOW WIRES WILL MEASURE APPROXIMATELY +1 VDC. THIS IS AN INTERNAL VOLTAGE ESTABLISHED BY THE CONTROL MODULE FOR REFERENCE.

**Probable Cause: Check Jacobs control module.**

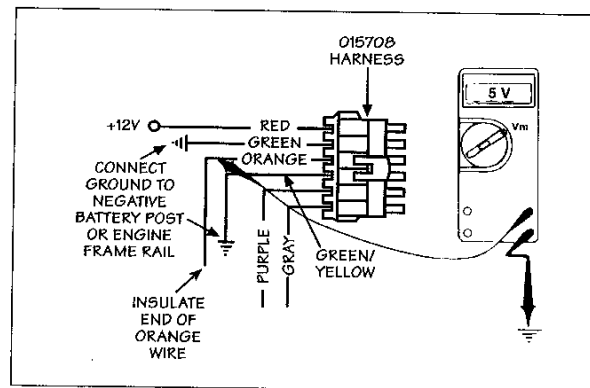

FIG. 1.1.27

**Correction:** Measure the voltage at the ORANGE wire of the control module. With system power ON, the voltage should measure +5 VDC +/- 0.5 VDC (Fig. 1.1.27). If this condition is not present, replace module.

# Problem: Engine Brake performance erratic/intermittent

**Probable Cause:** Check ground connection.

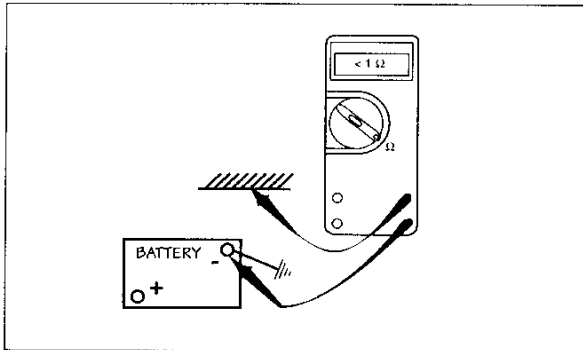

FIG. 1.1.28

**Correction:** The resistance between the engine block and the negative terminal of the battery must be less than 1 ohm (Fig. 1.1.28). The resistance between the GREEN wire of the engine brake control module and the negative terminal of the battery must be less than 5 ohms for proper module operation (Fig. 1.1.29).

**If vehicle is NOT equipped with ABS system:**

The GREEN/YELLOW wire must be grounded, preferably to the same point as the GREEN wire. These wires should be isolated from other system ground wires. The ORANGE wire must not be grounded and must be insulated when not in use (no ABS).

**Vehicles equipped with ABS system:**

Refer to specific ABS or vehicle manufacturer's electrical wiring diagrams or consult a Jacobs distributor for more information

**Probable Cause:** Check undercover wiring.

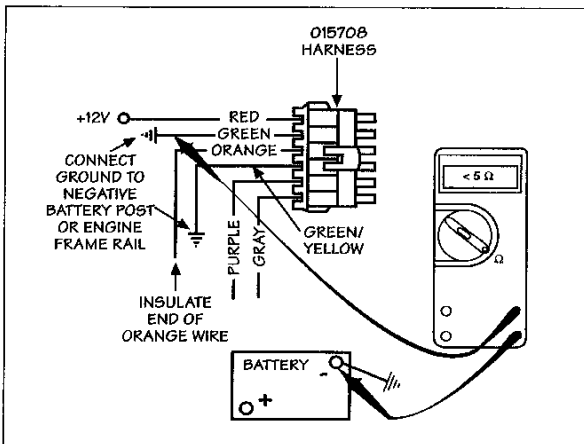

FIG. 1.1.29

**Correction:** Make sure solenoid wires are securely attached to the solenoid valves.

**Probable Cause:** Check for solenoid failure.

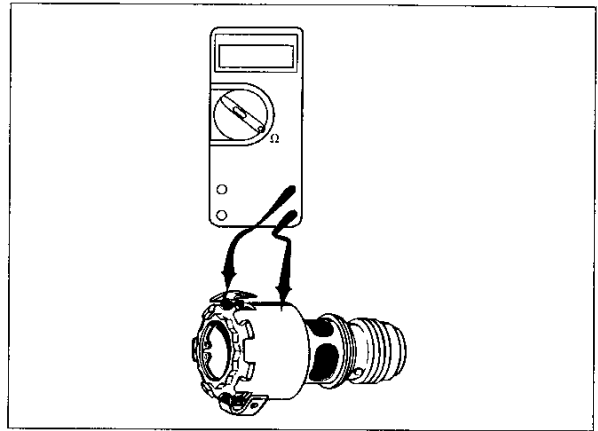

FIG. 1.1.30

**Correction:** Measure resistance of each solenoid valve (Fig. 1.1.30). Solenoid valves not within correct values must be replaced.

**NOTE:**

RESISTANCE MAY INCREASE SIGNIFICANTLY WHEN SOLENOID VALVES ARE ABOVE 100° F. SEE FIG. 1.1.9, PAGE 1.1.5, FOR ELECTRICAL REQUIREMENTS.

**Probable Cause:** Check Allison ATEC automatic transmissions.

**Correction:** Check that the BLUE/WHITE wire from the control module is connected to the ATEC ECM wire #211. The WHITE wire from the control module is connected to ATEC ECM wire #213. The BLACK wire from the control module must be insulated.

# Low Engine Speed Retarder Cutoff

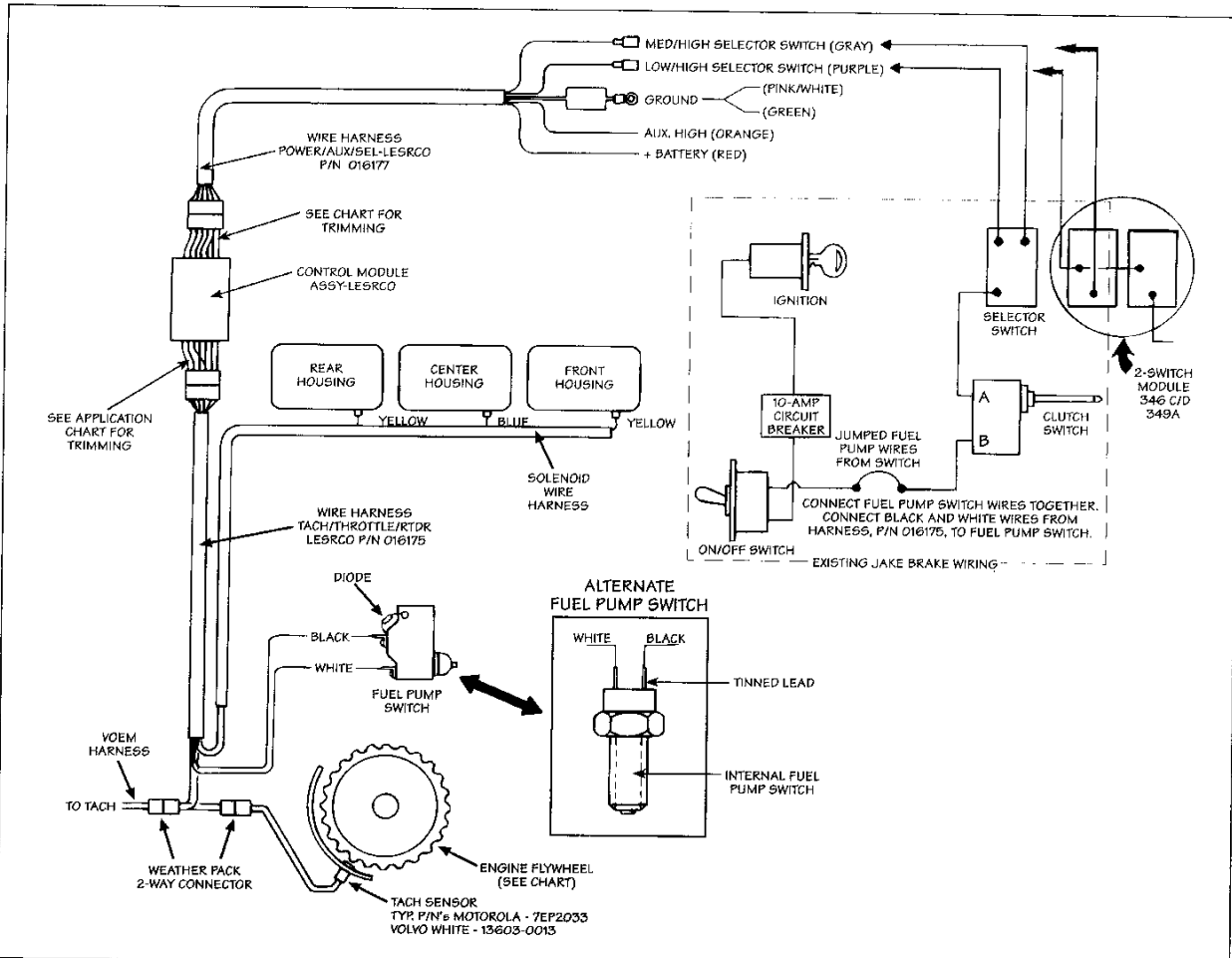

## Application Chart

Engine Make and Model	Flywheel Teeth	Cut-off Speed (RPM)	Trim Required
Mack, Cummins NT	118	850	Cut both green/yellow and blue/white
Cummins 10 Liter	105	950	Cut both green/yellow and blue/white
CAT 3406	113	880	Cut both green/yellow and blue/white
CAT 3406	113	1060	Cut green/yellow only
CAT 3306	132	910	Cut green/yellow only
CAT 3306	156	960	Cut blue/white only

Referring to the chart above, select the engine make and model and the desired cut-off speed (RPM) and cut the Control Module wires accordingly. Install caps on the ends of wires for insulation.

FIG. 1.1.31

# Troubleshooting: Low Engine Speed Retarder Cut-off

## Problem: Engine Brake will not operate.

**Probable Cause:** Power supply wire (red) disconnected, not energized.

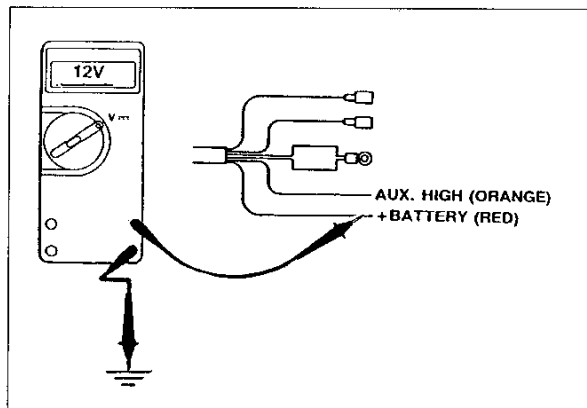

FIG. 1.1.32

**Correction:** Check that the connector between the vehicle power supply and the red line to the Jacobs control module is tight and free of any corrosion or oil. With the vehicle ignition turned on, +12 VDC must be measured at the red wire (Fig. 1.1.32). If not, continue with checks.

**Probable Cause:** Blown fuse or circuit breaker.

**Correction:** Replace fuse (10 amp) or reset circuit breaker. Search for cause of blown condition.

**Probable Cause:** Disconnected or bad fuel pump switch.

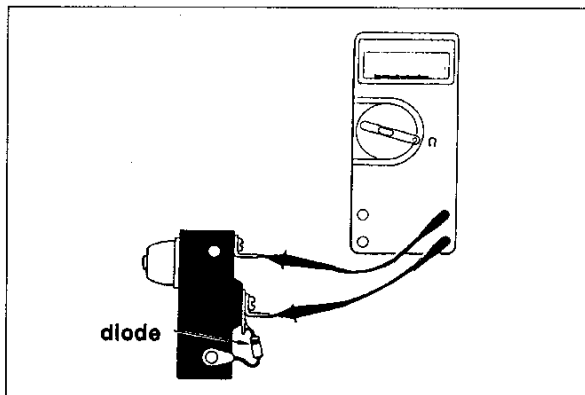

FIG. 1.1.33

**Correction:** Check that connections are made and are tight. Check for corrosion on terminals and clean as required. Check function of fuel pump switch. With the switch open, the VOM should register an "O.L." condition (Fig. 1.1.33). With the switch closed (plunger released), the VOM should register continuity. Replace or adjust as needed.

**Probable Cause:** Disconnected or failed clutch switch.

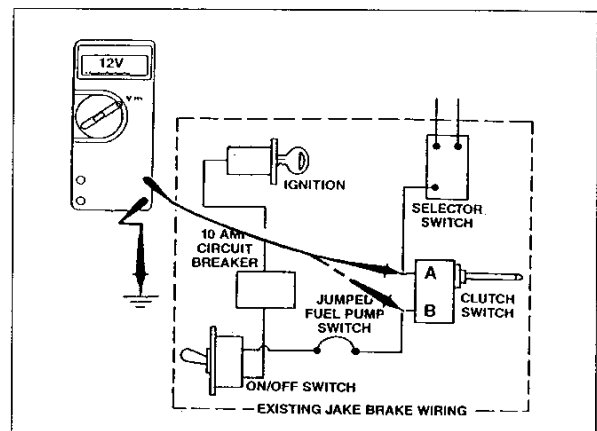

FIG. 1.1.34

**Correction:** Check that connections are tight on the clutch switch terminals. Check that there is no corrosion on connectors. Clean or replace as required. Check the clutch switch. With ignition ON and the Jacobs ON/OFF switch ON, measure the voltage at "A" (Fig. 1.1.34). VOM should read +12.5 VDC. At position "B" with switch closed, VOM should measure +12.5 VDC; with switch open, 0 VDC at position "B".

**Probable Cause:** Disconnected or failed selector switch.

**Correction:** Selector switch LO: 12.5 +/- 1 VDC must be applied to the purple wire to activate the blue solenoid output wire.

Selector switch MED/HI: 12.5 +/- 1 VDC must be applied to the gray wire to activate the yellow solenoid output wire.

**Probable Cause: Orange wire grounded.**

**Correction:** ABS (Aux) connection High: Orange wire for normal operation is not used. If connected to VOM, reading should be +5 VDC. If connected to ground, engine brake will not operate.

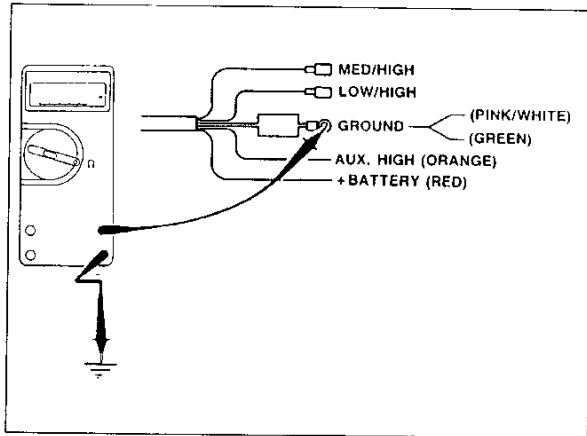

FIG. 1.1.35

**Probable Cause: Pink/white wire not grounded.**

**Correction:** ABS connection LOW: Pink/white wire is, for most applications, connected to ground with the green wire. If not connected to ground, brakes will not operate. VOM reading when not connected should be +5 VDC (Fig. 1.1.35).

**Probable Cause: Green wire not grounded or inadequately grounded.**

**Correction:** Ground reference must be 1 ohm or less measure with VOM.

**Probable Cause: Trim wires not properly cut.**

**Correction:** Check application chart (Fig. 1.1.31) for proper wires to be cut.

**Probable Cause: Failed or disconnected tach sender.**

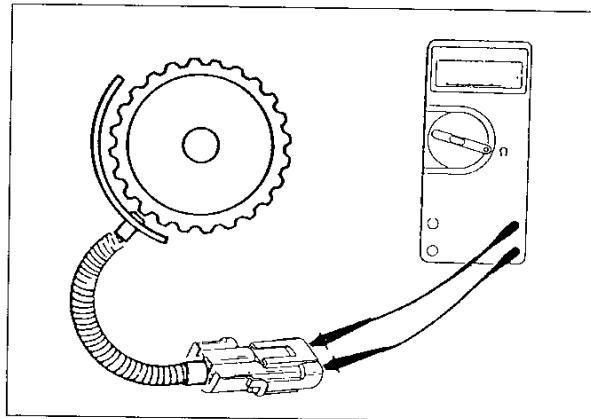

FIG. 1.1.36

**Correction:** Check that connections are tight with no evidence of corrosion. Disconnect harness at the control module. Measure resistance between tach sender wires; 50 - 300 ohms is a good reading (Fig. 1.1.36). The Motorola 7EP2033 or Volvo/White 13603-0013 will read 245 - 255 ohms.

Readings outside the accepted range indicate a short circuit or broken wire.

The sensor must be properly adjusted to manufacturers' specifications to generate the proper signal.

**Probable Cause: Bad control module.**

**Correction:** If all the above steps check OK, replace control module.

## Problem: Brake modulation does not work properly.

**Probable Cause:** Gray and purple input wires not connected or improperly connected to switch.

**Correction:** Check for tight connections and no corrosion.

- Gray wire to MED/HIGH selector position.
- Purple to LO selector position.

**Probable Cause:** Selector switch failure.

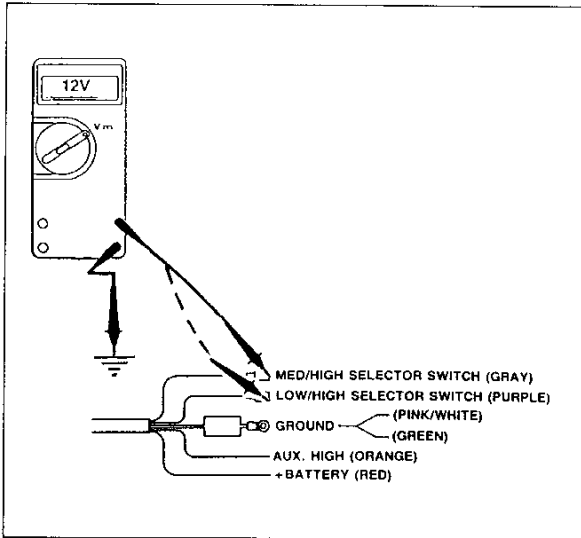

FIG. 1.1.37

**Correction:** With the selector switch in LO position, ignition ON and ON/OFF switch ON, measure voltage output at purple wire (Fig. 1.1.37). Proper reading should be 12.5 +/- 1 VDC. Measure output at gray wire. Output should be 0 VDC. Select HI position on selector. VOM should read 12.5 +/- 1 VDC at each output terminal.

**Probable Cause:** Blue and yellow output wires disconnected or reversed.

**Correction:** Check to be sure connectors are tight and there are no signs of corrosion. Check that the blue wire is attached to the center housing (3-housing installation) or the rear housing (2-housing installation). Insure the yellow harness is attached to the front or first and third housings.

With the engine operating, transmission in neutral, dash switch on, selector switch on HI, accelerate engine to high idle and then release throttle. The VOM readings at the blue and yellow wires should be 12 VDC (Fig. 1.1.38).

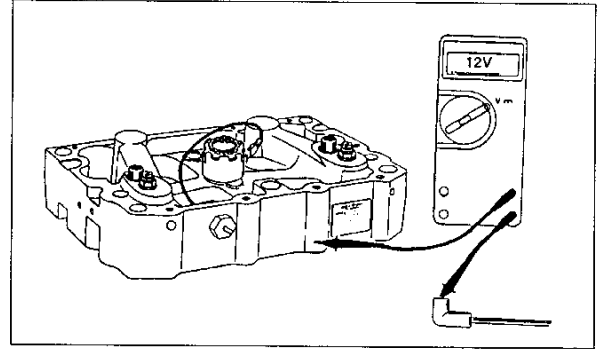

FIG. 1.1.38

Check that 12 VDC is present at housing connector(s). If engine brake does not operate, remove valve cover(s).

**Probable Cause:** Solenoid valve does not function.

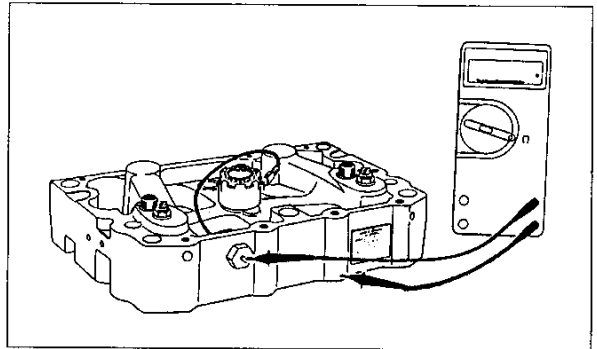

FIG. 1.1.39

**Correction:** Check to be sure solenoid harness is properly connected.

With electrical power OFF, check resistance of solenoid coil. VOM should read 9.75 - 10.75 ohms (Fig. 1.1.39). If it does not, replace solenoid valve.

## Problem: Engine Brake operation erratic.

### Probable Cause: Improper ground.

**Correction:** Using the VOM, measure the resistance from the point the green wire is grounded to the engine block. Resistance must be no greater than 1 ohm. If resistance is greater than 1 ohm, the ground wire must be repositioned to the engine block.

The green ground and the pink/white wire must be grounded alone. Grounding with other components at a common point may lead to "phantom" signals causing erratic operation.

### Probable Cause: Improper or insufficient tach signal.

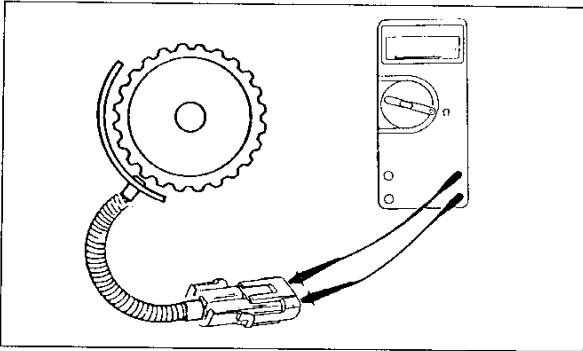

FIG. 1.1.40

**Correction:** Disconnect Weather Pack connector from Jacobs control module. Measure the resistance between the two wires from the tach sender (Fig. 1.1.40). An acceptable reading will be from 50 to 300 ohms. The Motorola 7EP2033 or Volvo/White 13603-0013 will read between 245 - 255 ohms. Readings outside this range indicate a short circuit or broken wires.

### Probable Cause: Check that the tach sender is properly adjusted.

**Correction:** With engine running, measure AC voltage signal between 500 - 800 RPM and record reading (Fig. 1.1.41). Above 1000 RPM, the VAC should be greater. If it is not, replace the sending unit.

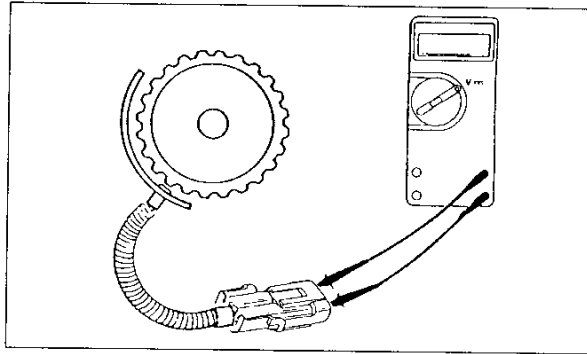

FIG. 1.1.41

### Probable Cause: Insufficient tach ground

**Correction:** Measure the resistance of each tach sender wire to ground (Fig. 1.1.42). The one wire with a reading of 0 ohms is at ground potential. This wire should be cut and the two ends insulated. If the problem continues, add a separate sending unit for the low speed signal.

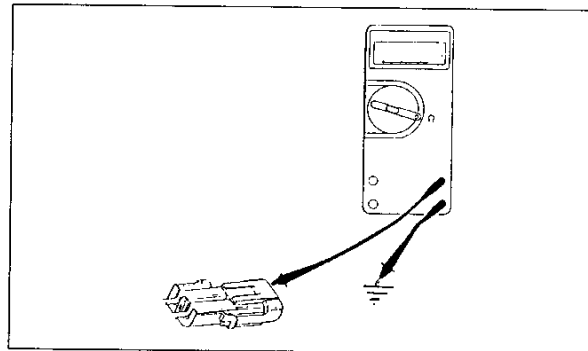

FIG. 1.1.42



# Basic Wiring Diagrams

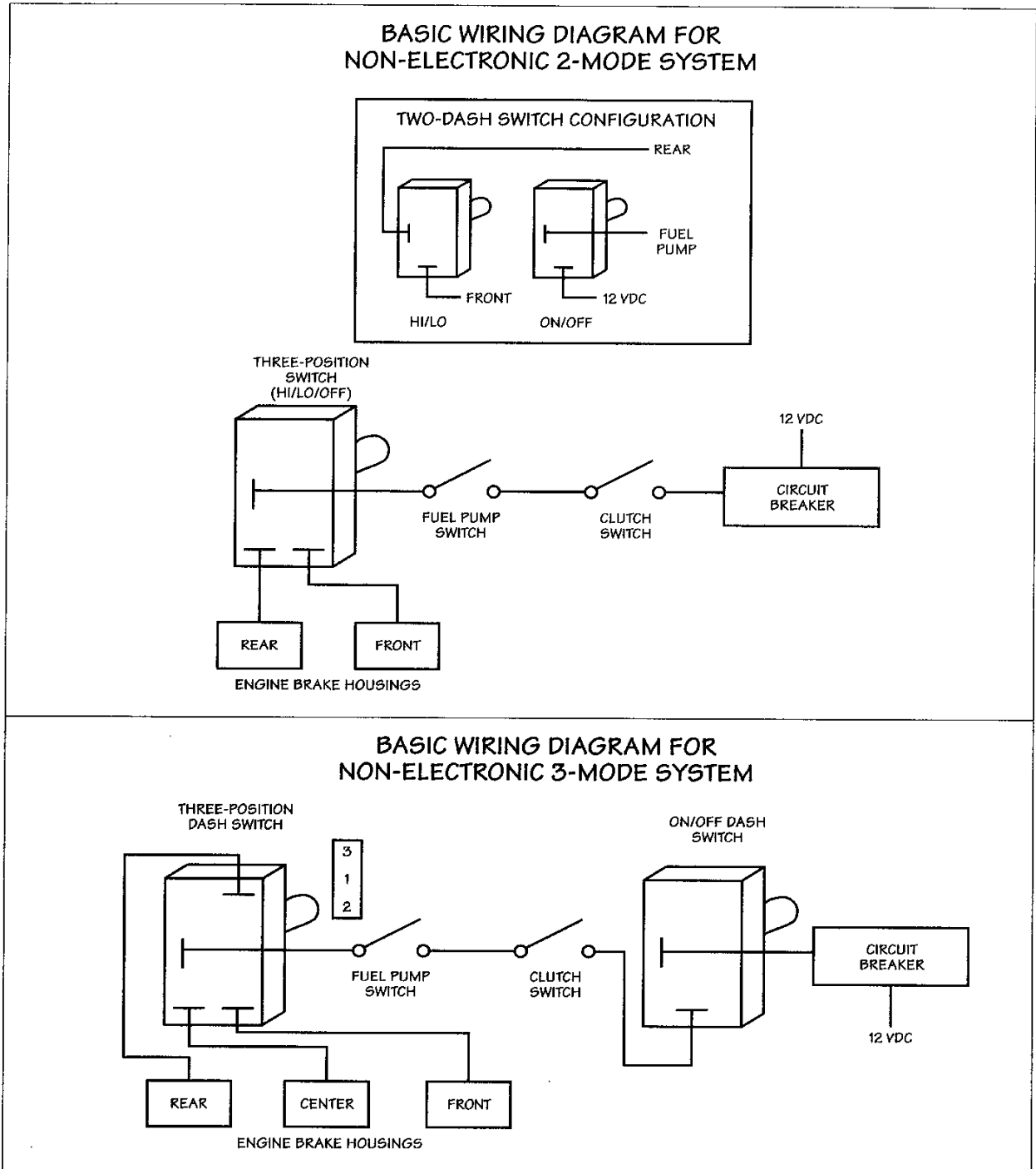

FIG. 1.1.43

# Caterpillar Cab Controls

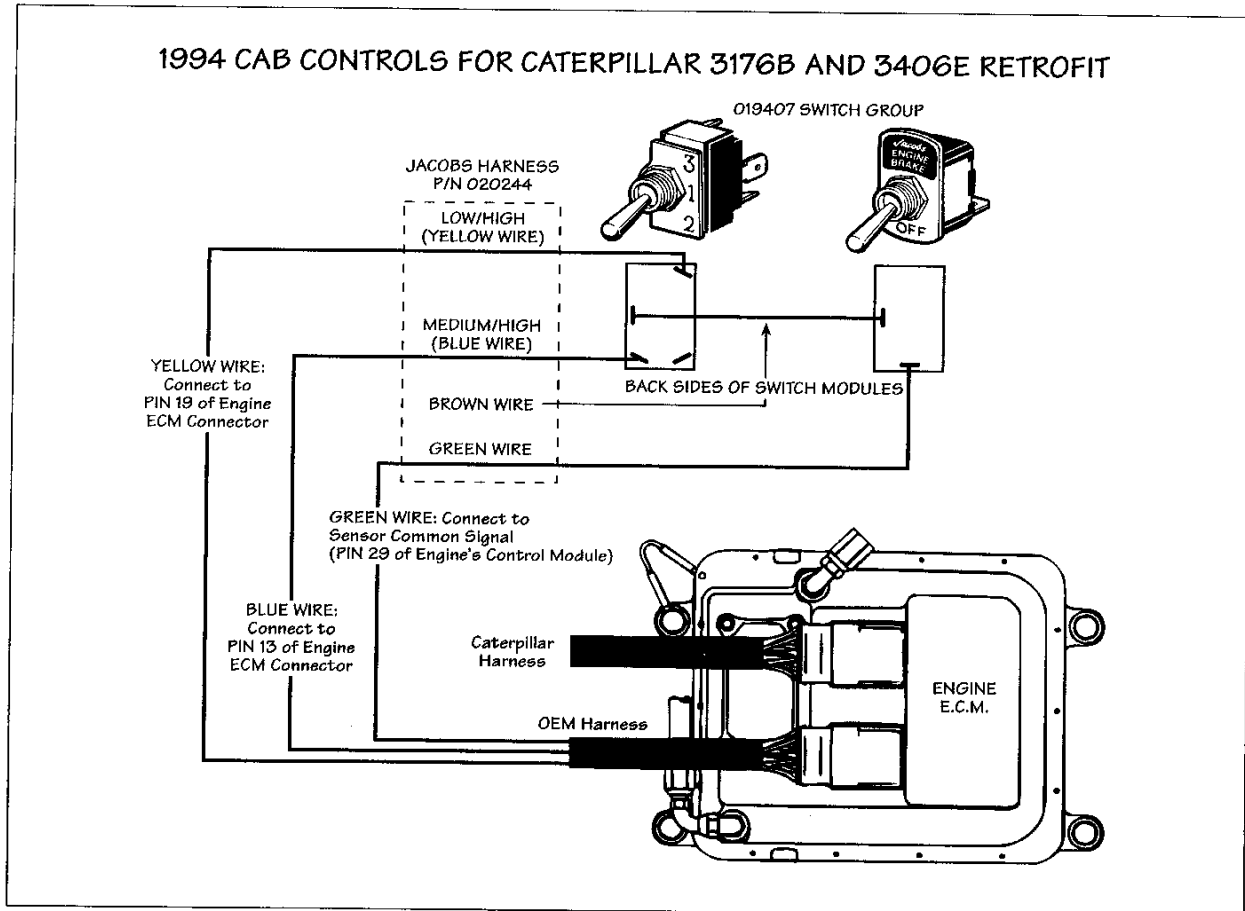
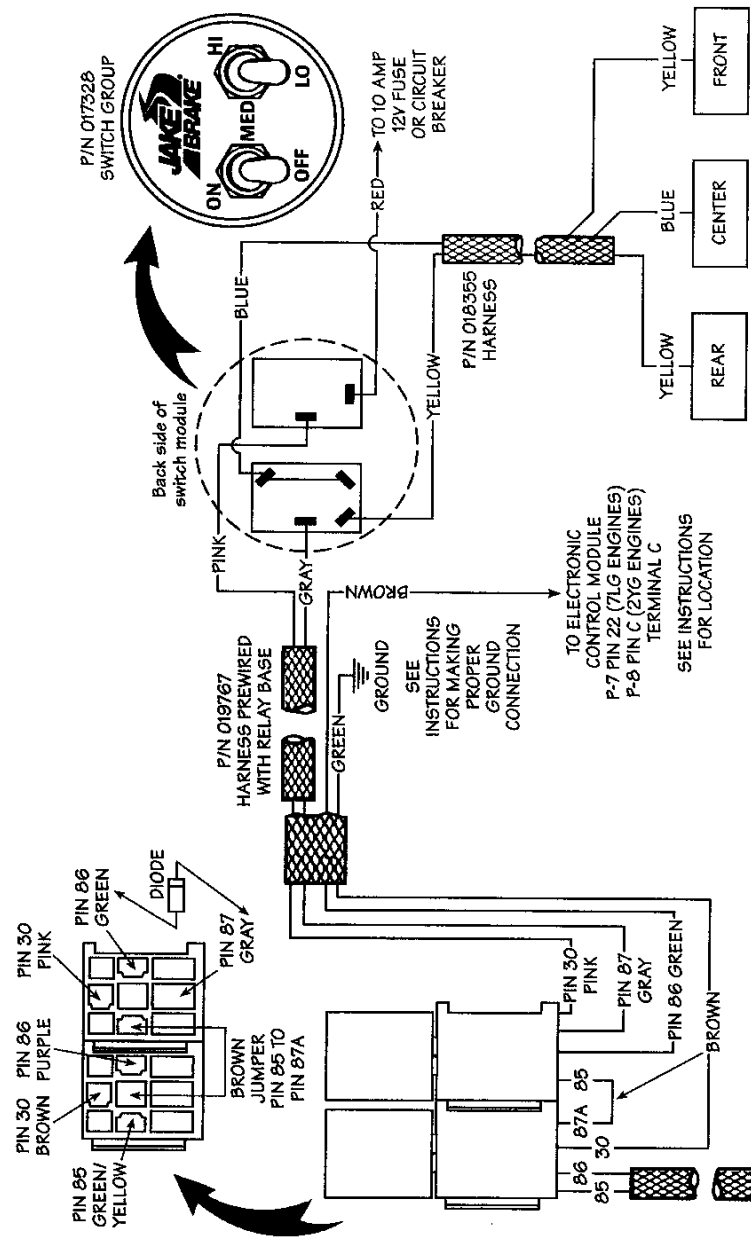

FIG. 11.144

# Wiring Diagrams for Caterpillar Engines

JAKE BRAKE® MODELS C317, C317A, 317B, 317C, 317D AND 317E WIRING DIAGRAM FOR CATERPILLAR 3176 ENGINES WITH SERIAL NUMBER PREFIXES OF 7LG AND 2YG

VEHICLES WITH ANTI-LOCK BRAKING SYSTEM (ABS)



Jacobs® and Jake Brake® registered trademarks of Jacobs Vehicle Equipment Company  
22 East Dudley Town Road  
Bloomfield CT 06002

FIG. 1.1.45

# Wiring Diagrams for Caterpillar Engines

JAKE BRAKE® MODELS C317, C317A, 317B, 317C, 317D AND 317E WIRING DIAGRAM  
FOR CATERPILLAR 3176 ENGINES WITH SERIAL NUMBER PREFIXES OF 7LG AND 2YG

VEHICLES WITHOUT ANTI-LOCK BRAKING SYSTEM (ABS)

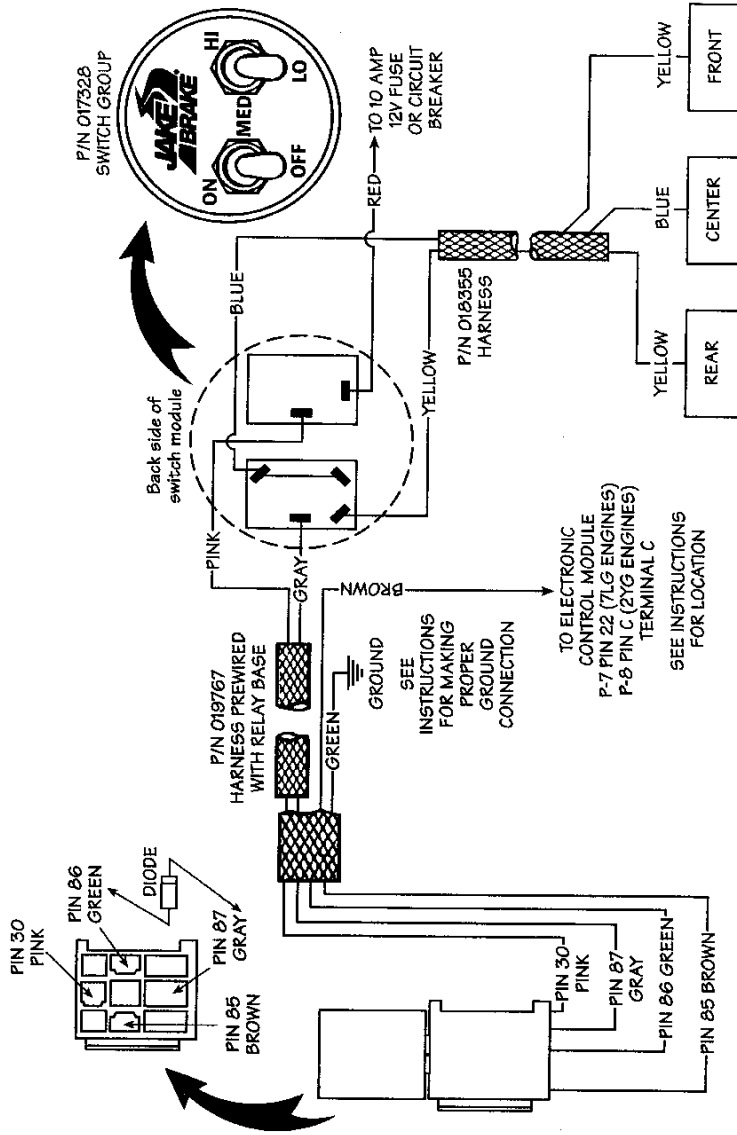

FIG. 1.1.46

**Jacobs®**

Jacobs® and Jake Brake® registered trademarks of  
Jacobs Vehicle Equipment Company  
22 East Dudley Town Road  
Bloomfield CT 06002

P/N 018681

© 1995 Jacobs Vehicle Equipment Company

5/95

# Wiring Diagrams for Caterpillar Engines

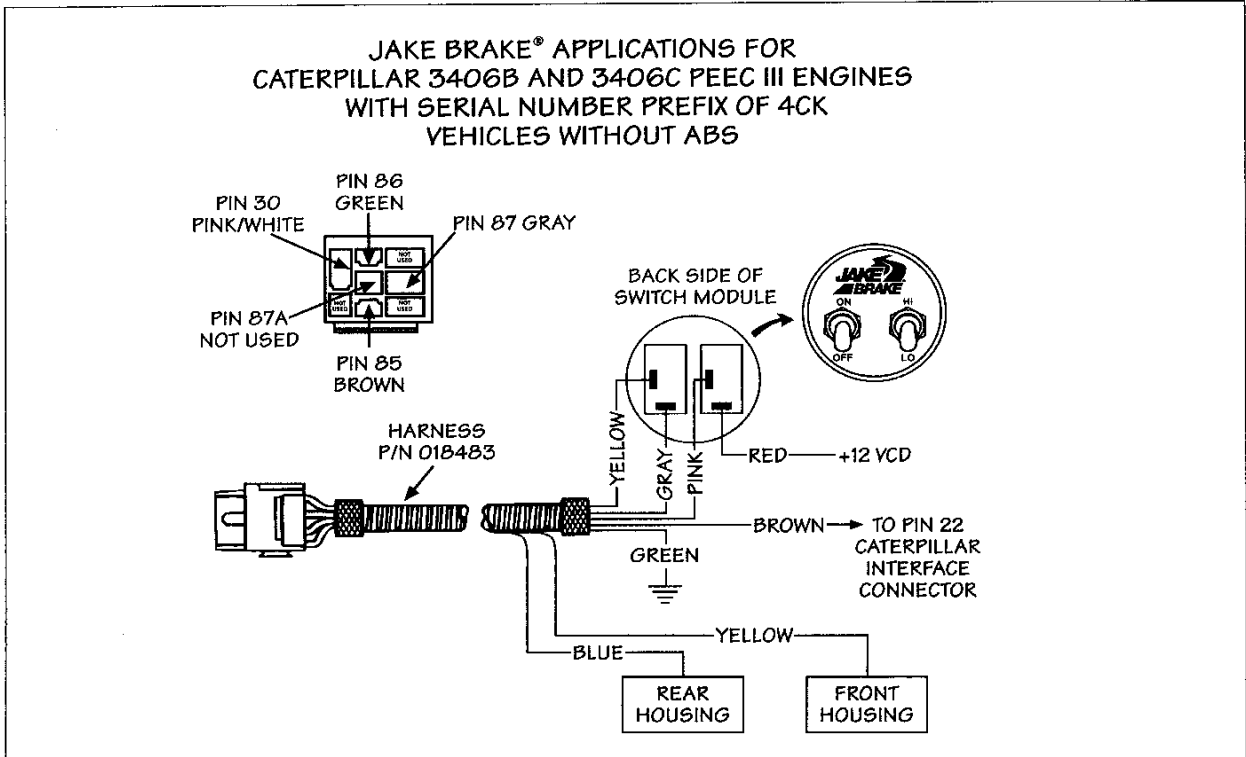
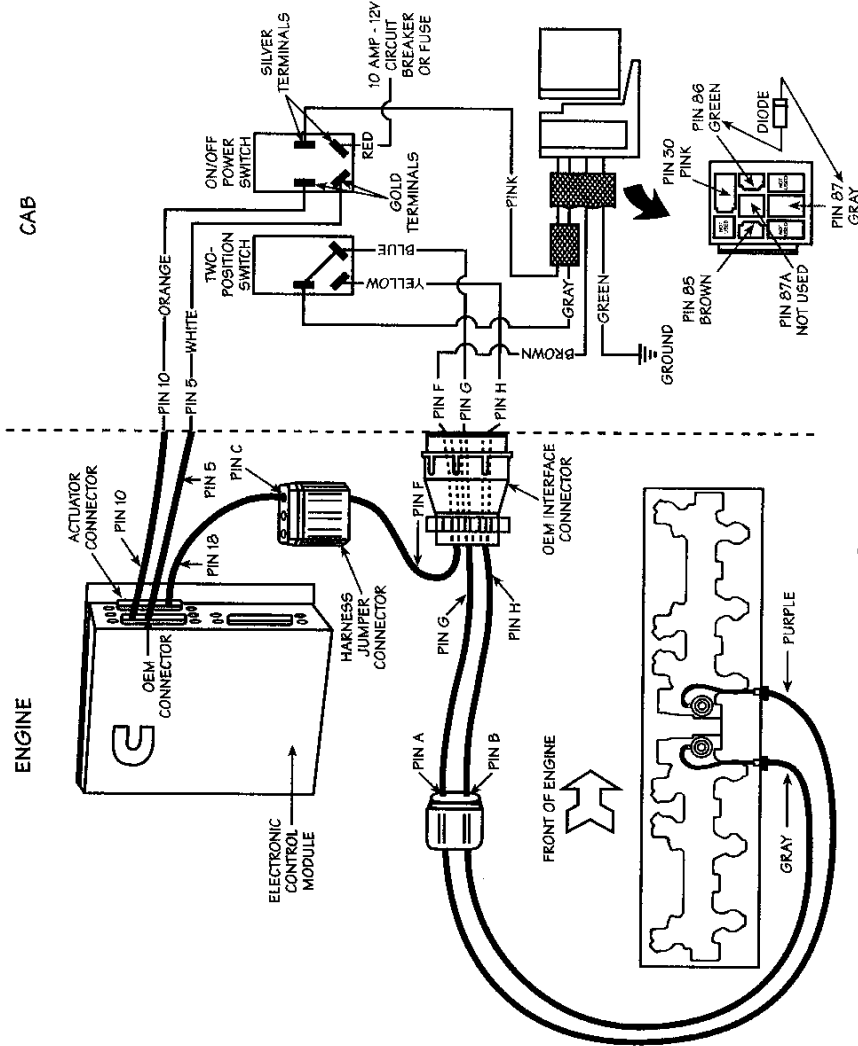

FIG. 1.1.47

# Wiring Diagrams for Cummins CELECT

JAKE BRAKE® WIRING DIAGRAM FOR CUMMINS L10 CELECT AND M11 ENGINES



**Jacobs®**

Jacobs® and Jake Brake® registered trademarks of  
 Jacobs Vehicle Equipment Company  
 22 East Dudley Town Road  
 Bloomfield CT 06002

P/N 018115

4/95

FIG. 1.1.48



# Wiring Diagrams for DDC Engines

## JAKE BRAKE® MODELS 760, 760A AND 765 DDEC SERIES III WIRING DIAGRAM

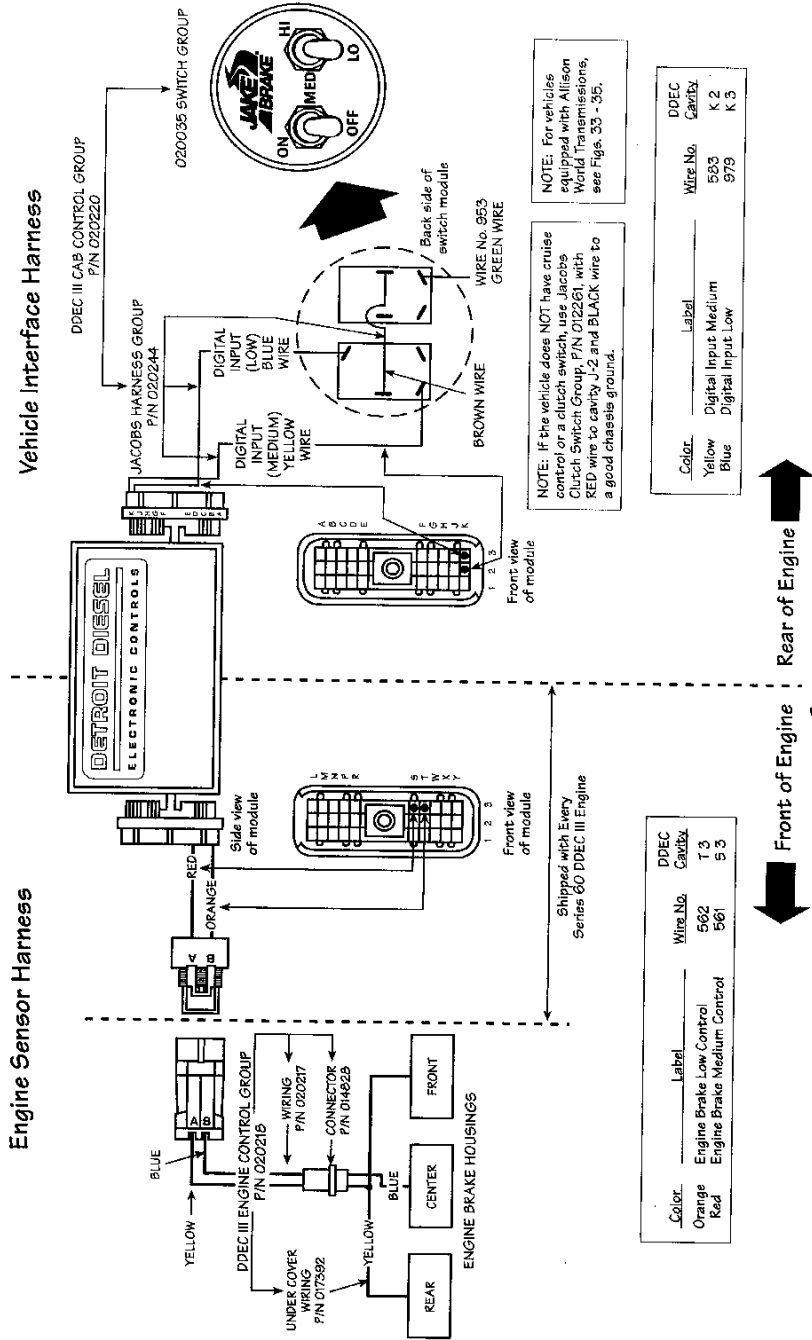

FIG. 1.1.50

Jacobs® and Jake Brake® registered trademarks of Jacobs Vehicle Equipment Company  
22 East Dudley Town Road  
Bloomfield CT 06002

P/N 020582

© 1995 Jacobs Vehicle Equipment Company

4/95



# Wiring Diagrams for DDC Engines

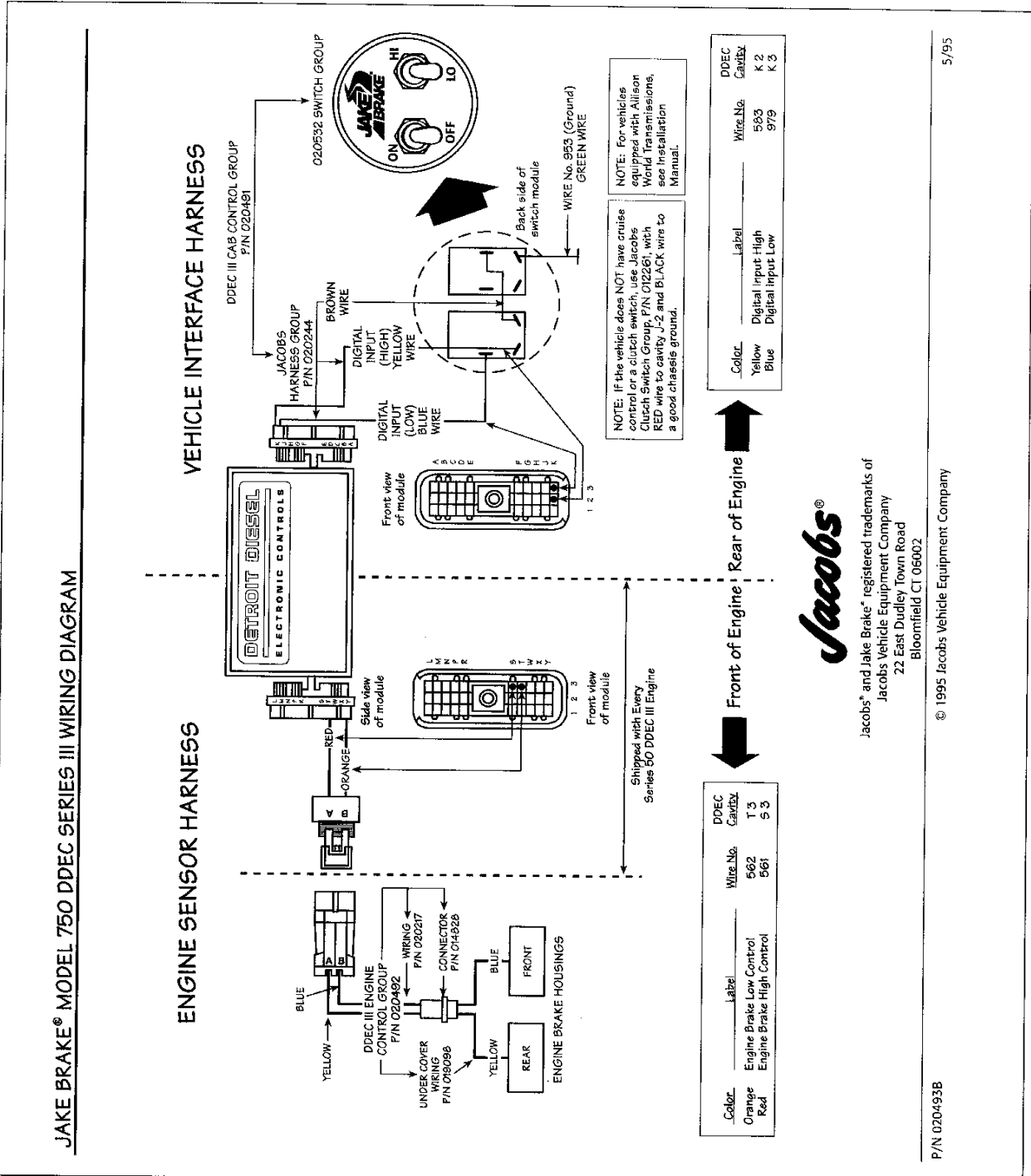

FIG. 1.1.51



Jacobs® and Jake Brake® registered trademarks of  
Jacobs Vehicle Equipment Company  
22 East Dudley Town Road  
Bloomfield CT 06002

© 1995 Jacobs Vehicle Equipment Company

# Wiring Diagrams for DDC Engines

## JAKE BRAKE® MODEL 71/92A DDEC SERIES III WIRING DIAGRAM

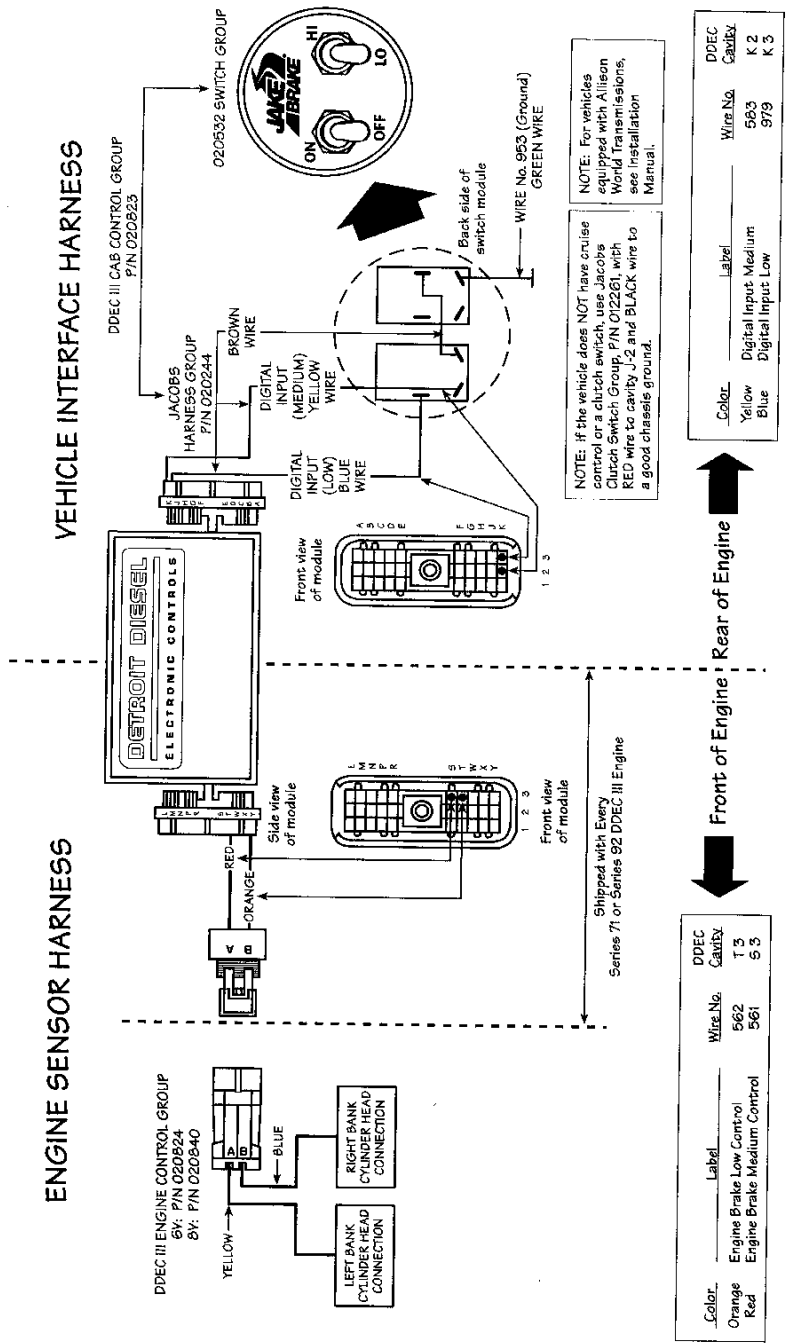

Jacobs® and Jake Brake® registered trademarks of Jacobs Vehicle Equipment Company  
72 East Dudley Town Road  
Bloomfield CT 06002

P/N 020626

© 1995 Jacobs Vehicle Equipment Company

1/95

FIG. 1.152

# 1.2 Hydraulic/Mechanical

## Theory of Operation

When an engine brake is energized, a power-producing diesel engine is converted into a power-absorbing air compressor. As shown in the schematic diagrams below, this is accomplished by the motion of a master-slave piston arrangement. Near the top of the normal compression stroke, the cylinder exhaust valves open releasing a compressed, cylinder charge to the exhaust system, preventing the engine from producing positive power.

## Operational Sequence

### Step 1 (Fig. 1.2.1)

The main components of the hydraulic system are the solenoid valve, the control valve, the master piston and the slave piston. The control valve and the solenoid valve regulate the flow of the engine oil, which acts as Jake Brake hydraulic fluid. As shown in this figure, when the Jake Brake is not in operation, the solenoid valve is closed, preventing engine oil from entering the system and allowing oil to drain to the sump from the previous operation.

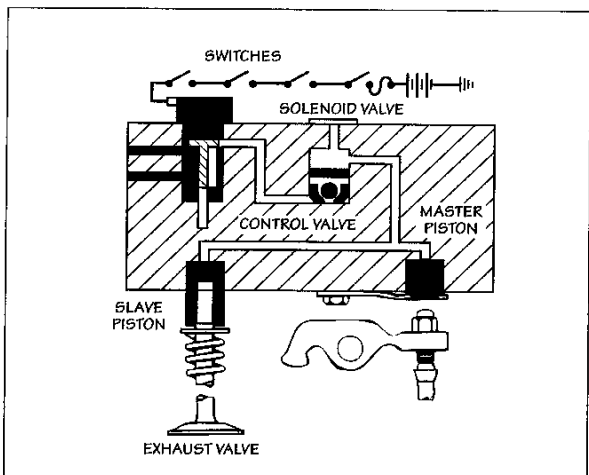

FIG. 1.2.1

### Step 2 (Fig. 1.2.2)

When the solenoid valve is actuated, oil fills the passageway to the control valve. This exerts enough force to raise the control valve inside its bore and unseat the check ball inside the control valve. Engine oil then flows out through the control valve cross-port, fills the passageway between the slave and master pistons, and forces the master piston down against the injector rocker lever adjusting screw, or in some engines, the exhaust rocker lever adjusting screw of an alternate cylinder. This sequence connects engine camshaft motion to engine brake timing.

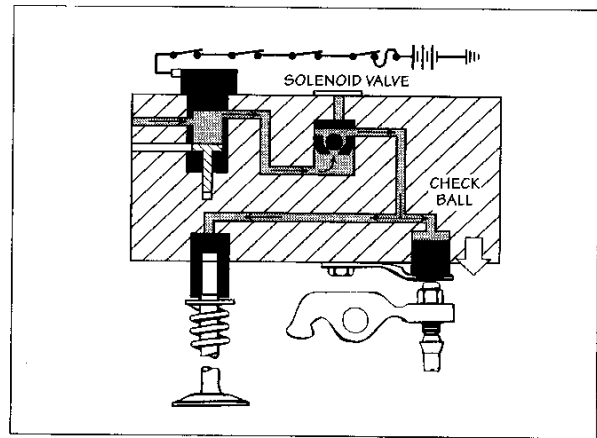

FIG. 1.2.2

### Step 3 (Fig. 1.2.3)

When the rocker lever adjusting screw contacts the master piston, oil pressure increases and seats the check ball in the control valve. This creates a closed hydraulic system between the slave and master pistons. The oil pressure in the closed system increases and forces the slave piston down against the exhaust valve crosshead (bridge). The exhaust valves then open just before the engine piston reaches top dead center, releasing compressed air from the cylinder.

When electrical power is discontinued to the solenoid valve, engine lube oil is blocked from entering the brake housing. The inner control valve spring forces the control valve to the bottom of the control valve bore. The entrapped oil from the master piston/slave piston circuit can now escape from under the control valve cover, ending the engine brake cycle.

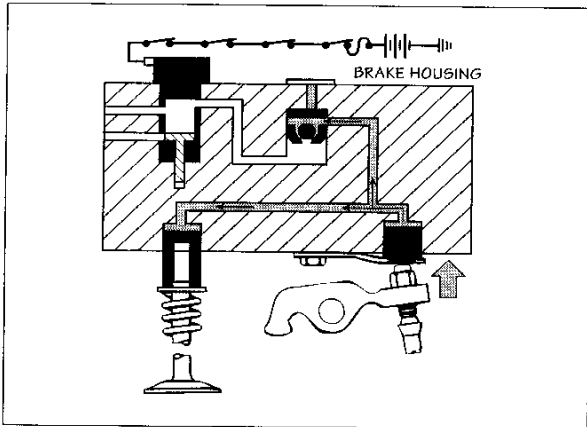

FIG. 1.2.3

## Brake Housings and Rocker Groups Inspection

1. Before inspecting the brake housings and rocker groups, remove over-engine equipment such as air intake and turbocharger crossover pipes, plus the valve mechanism upper covers. With the valve covers removed, start the engine and let the engine warm up to operating temperature. Manually depress the solenoid cap and make the following checks



WEAR EYE PROTECTION AND DO NOT EXPOSE YOUR FACE OVER ENGINE AREA. TAKE PRECAUTIONS TO PREVENT OIL LEAKAGE DOWN ON THE ENGINE.

WHENEVER ENGINE IS RUNNING AND VALVE COVERS ARE REMOVED, OIL SPLASHING IN THE ENGINE BRAKE AREA COULD CAUSE PERSONAL INJURY.

- a. In Models 53/71/92 series, Models 59/903, 336 and Model 404, check all oil connector screws and seals to ensure that oil is being transferred to the adjacent housings and screws are not loose or broken.
- b. Inspect the nylock plugs on housing ends where applicable to make sure none are leaking.
- c. As solenoid cap is depressed, check master piston assemblies to ensure that no binding occurs and all drop from their respective bores evenly and immediately.

### NOTE:

IN SOME CASES, IDLE OIL PRESSURE IS NOT ADEQUATE TO OPERATE THE ENGINE BRAKE (SEE FIG 1.2.5 FOR OIL PRESSURE REQUIREMENTS).

IF THIS CONDITION EXISTS, RAISE THE RPMS BY USING THE THROTTLE, RELEASE THE THROTTLE AND THEN MANUALLY DEPRESS THE SOLENOID.

- d. Look for any cracks in the engine brake housings.
- e. Look for leaks from the solenoid upper seal area.
2. Release solenoid cap and check for:
  - a. Immediate shut off. Check the condition of oil exhausted from the control valve cover. If exhausted oil has bubbles or is foamy in appearance, air is present in the system. Repeat this procedure several times. If aeration continues, the source of aeration must be determined before continuing with diagnostic procedures. Aeration causes a spongy brake because of reduced piston travel.
  - b. Quick and complete master piston retraction.

## Engine Brake Housing Oil Pressure Check

To properly troubleshoot the engine brake, the mechanic **must** know the supply oil pressure reading to the engine brake housing. The mechanic must understand that the oil pressure reading on the instrument panel gage is **not** the same as at the engine brake housings.

Insufficient oil pressure to compress the control valve return spring or to cause deflection of the master piston return spring will prevent the brake from working. Partial or incomplete compression and deflection of these springs from marginal oil pressure supply will produce marginal, if any, brake performance.

**NOTE:**

WHEN MAKING OIL PRESSURE CHECKS ON JACOBS MODELS 401,404 AND 760 (NOT 760A OR 765), IT IS NECESSARY TO START AT IDLE SPEED AND THEN GRADUALLY INCREASE RPMS. THE ONE WAY CHECK VALVE IN THE HOUSING ENTRANCE PREVENTS THE TOTAL ESCAPE OF ENGINE OIL. IF FULL RPM OIL PRESSURE IS TAKEN FIRST, THAT PRESSURE IS ACCURATE. HOWEVER, WHEN THE RPMS ARE LOWERED, THERE IS ENOUGH ENTRAPPED OIL TO GIVE AN ARTIFICIALLY HIGHER READING. TO CORRECT THIS CONDITION, LOOSEN THE SOLENOID ADAPTERS AND ALLOW THE PRESSURE TO BLEED DOWN, THEN RETIGHTEN THE ADAPTER AND RECORD THE PRESSURE. SHUT DOWN THE ENGINE BEFORE LOOSENING THE SOLENOID.

If oil pressure is insufficient for engine brake operation, the engine should be examined by an authorized facility. Oil may be leaking past cam bearings, rocker bushings, or other oil-pressure-fed engine bearings, if worn. This can produce insufficient oil supply to operate engine brakes. Brakes could operate an higher RPM levels, but fade out at lower RPM levels.

On some of today's new diesel engines which operate at lower average regulated oil pressures, oil pressure values below 1000 RPM are not of great concern. Below this engine speed, the engine brake is least efficient. The old standard that the engine brake should stall the engine at idle as a troubleshooting technique is now outdated.

High oil pressure or "over pressure" can also cause poor braking by forcing the control valves to shut off the engine brake units. This can occur on models that have the control valve double spring over-pressure system. The double spring system allows the control valve to shut off the engine brake before oil pressure reaches a level which can cause the slave piston to jack.

See Fig. 1.2.5 for specific oil pressure requirements for the control valve springs used in the brake model you are working on.

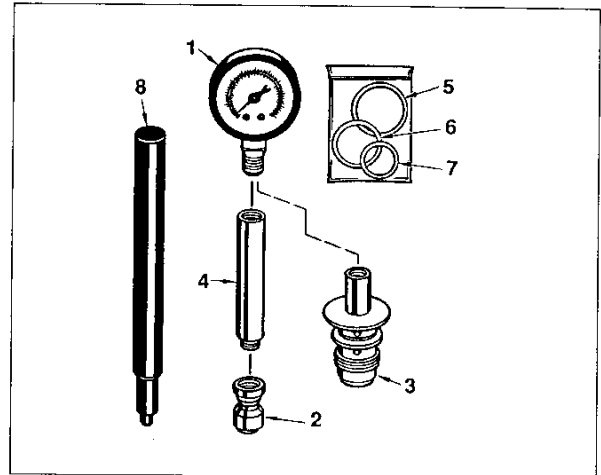

FIG. 1.2.4

**Oil Pressure Test Kit, P/N 018280**

Ill. No.	Part Name
1	Pressure Gauge
2	Body, Control Valve - Pressure Test
3	Solenoid Valve - Pressure Test
4	Adaptor - Pressure Test
5	Solenoid Seal Ring
6	Solenoid Seal Ring
7	Solenoid Seal Ring
8	Control Valve Cover Removal Tool
NI	Tool Box
NI	Instructions - Pressure Test
NI	Chart, Oil Pressure

The tools in this kit can be used to determine engine oil pressure available for operation of any model Jacobs engine brake. Complete instructions are contained in the kit.



**WARNING**  
TO PREVENT PERSONAL INJURY, WEAR SAFETY GLASSES AND USE CAUTION WHEN WORKING ON AN ENGINE. WHEN ENGINE IS RUNNING, COVER OPEN AREAS WITH TOWELS TO REDUCE OIL SPRAY.

## Preliminary Checks

1. Before starting engine, check the following:
  - a. Oil level on dipstick. Overfull or underfull condition in crankcase will cause aeration in the engine brake hydraulic system.  
  
If oil level is questionable, refer to manufacturer's charts for correct dipstick calibration. Re-calibrate if necessary.
  - b. Condition of engine lubricating oil for presence of fuel or water or both. This indicates engine problems and must be corrected.
2. Check engine brake slave piston setting and engine valve injector settings. See applicable installation and service literature.
3. Weak, intermittent or no engine braking may be due to electrical, hydraulic or mechanical problems. Prior to using the test kit, check all electrical components, switches, wiring and slave piston adjustments.

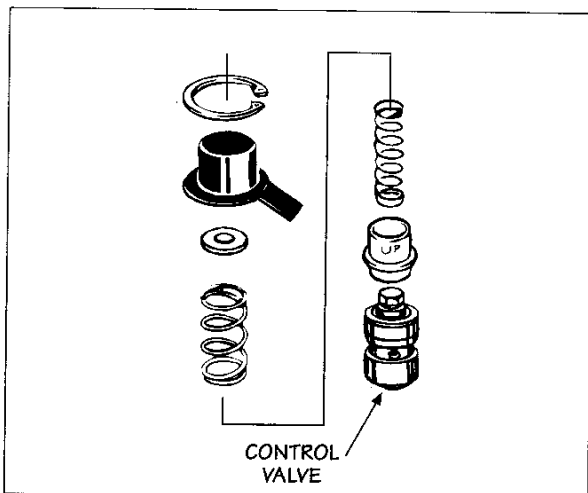

FIG. 1.2.5

**NOTE:**

COMPONENTS USED WITH THE CONTROL VALVES IN VARIOUS ENGINE BRAKE MODELS MAY DIFFER (SEE FIG. 1.2.5), BE SURE ALL PARTS ARE REINSTALLED IN THE SAME ORDER AS REMOVED. REFER TO INSTALLATION MANUALS FOR SPECIFIC MODELS IN QUESTION.

EARLY PRODUCTION



P/N 001521

FIG. 1.2.6

## Control Valve Component Inspection



REMOVE CONTROL VALVE COVERS CAREFULLY. CONTROL VALVE COVERS ARE UNDER LOAD FROM THE CONTROL VALVE SPRINGS. REMOVE WITH CARE TO AVOID PERSONAL INJURY.

1. If any of the above problems are found, inspect the control valve components of the questionable cylinder for the following:
  - a. Broken control valve springs.
  - b. Smooth movement of the control valve in its bore.
  - c. Spring tension and check ball seating in the base of the control valve body.
2. Apply pressure to the control valve cover and slowly remove the hex head capscrew or snap ring. Slowly raise the cover until all spring pressure is relieved.
3. Remove the control valve springs and other components, if applicable.
4. Using needle-nose pliers or fingertips, reach into the bore and grasp the stem of the control valve. Pull the valve straight up and out of its bore. If binding occurs, clean or replace if necessary.

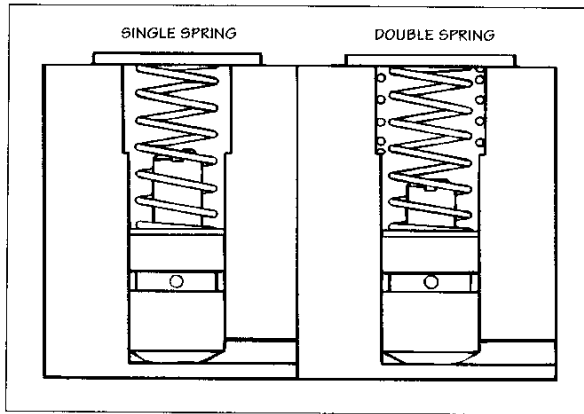

FIG. 1.2.7

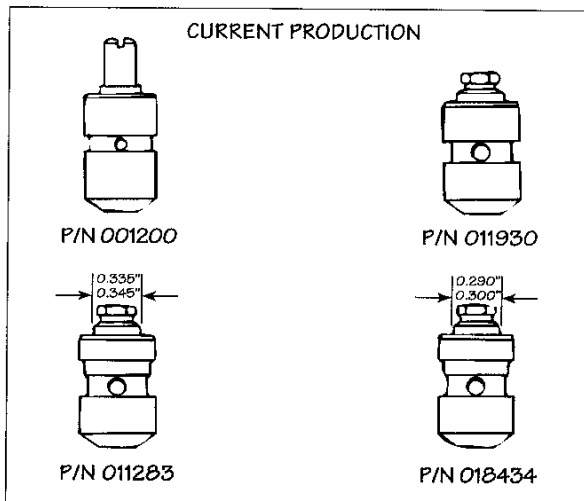

FIG. 1.2.8

## Engine Brake Oil Pressure Requirements

### Current Production Engine Brake Models

Model	Control Valve	Control Valve Springs	Fill Flow PSI	Over Press. PSI
317B/C	018434	010504/19190	18-50	75
C336/A	011930	007500/010843	16-80	95
346D	011930	011435/011434	16-78	100
349/A	011930	011823/011434	20-87	95
404BG	011283	011823/011253	20-53	75
404D	011283	007500/011253	25-56	78
425A	011930	007500/001519	22-53	65
430	011930	007500/010843	16-80	95
440/A	011930	007500/011253	25-65	70
680A	011930	003109/010843	35-90	110
680B	011930	011823/010843	25-85	90
71/92A	011930	007500/011434	15-77	85
760A/765	011930	018179/001519	25-56	78

### Past Product Engine Brake Models

C317A	018434	001518/011253	25-56	78
C346	001200	001518	25+	N/A
C346B/C	011930	011435/011434	16-78	100
20	001200	001012	20 - 58	N/A
30/25B	001521*	001518/001519	25-56	78
30E	011283	007500/001519	15-54	66
59/59A	001521	003109/003110	35-78	92
59B	001521	003109/010843	35-104	110
903	011930	001518/010843	25-80	90
K200	001200	003410	6+	N/A
K1150	001200	006536	16+	N/A
K1200	001521	007500/001519	15-54	66
400, 400H	011283	007500/001519	15-54	66
401A/B/C	007505*	007500/011253	15-46	65
404/404B	011283	011823/011253	20-53	75
404C	011283	007500/011253	25-56	78
425/420	011930	007500/001519	22-53	65
445	011930	007500/011253	25-65	70
675	001200	001518	25+	N/A
675A	011930	011435/011434	16-78	100
53A	011930	001012/001519	22-53	65
760	011930	001518/001519	25-56	78

\* The Jacobs control valve, P/N 007505, has been superseded by P/N 011283. The Jacobs control valve, P/N 001521, has been superseded by P/N 011930.

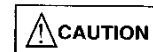

DO NOT INTERMIX SPRING COMBINATIONS.

# 1.3 General Problem Analysis

## Tools and Parts Available for Servicing and Maintaining Jacobs Engine Brakes

### Tool Box

Tool Box for All Models: P/N 017469

Tool Boxes for Engine Families:

Caterpillar: P/N 017465

Cummins: P/N 017468

Detroit Diesel: P/N 017466

Mack: P/N 017467

Tool Box only: P/N 017471

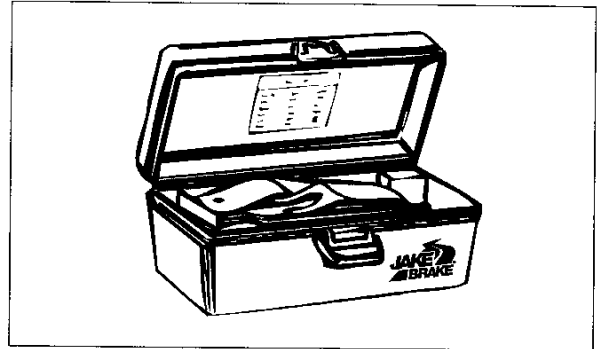

### Oil Pressure Test Kit

Use for all Jake Brake models to troubleshoot weak and/or no engine brake conditions.

Check engine oil supply pressure at the engine brake solenoid valve and the control valve.

Pressure gage, three adaptors, seals and control valve cover release tool packaged in a sturdy case.

Includes laminated chart with specifications for all past and current models.

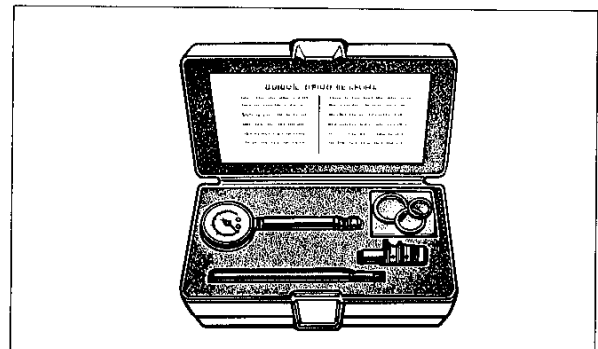

### Tune-up Kits

Genuine Jacobs replacement parts.

Everything needed for a complete tune-up in one convenient package.

Complete step-by-step instructions.

All parts include the latest Jacobs design improvements.

All parts backed by full Jacobs replacement parts warranty.

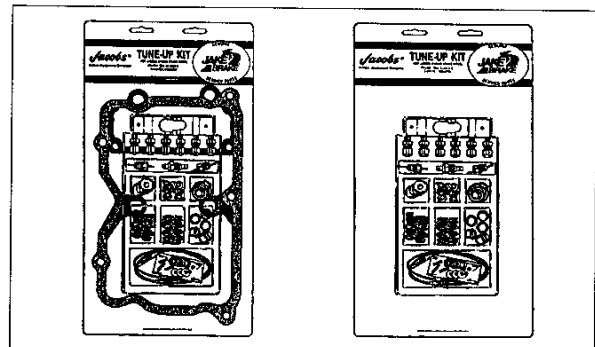



## Problem: Engine fails to start

**Probable Cause:** Solenoid valve stuck in "on" position.

**Correction:** Ensure that electrical current is off to engine brakes. If solenoid valve remains "on" (cap down) with current off, replace solenoid valve.

## Problem: Engine brake will not operate

**Probable Cause:** Blown fuse, open electrical leads.

**Correction:** Look for short circuit in wiring. Replace any broken, brittle or chafed wires. Check solenoid tab for signs of shorting; replace if necessary. Replace fuse (10 amp).

**Probable Cause:** On/off switch, clutch switch, throttle switch or multi-position switch out of adjustment or defective.

**Correction:** Use a volt/ohm meter to make certain that there is electrical current available at both terminals of each switch. Readjust if needed or replace if voltage will not pass through switch.



DO NOT TOUCH ELECTRICAL CONNECTION  
WHEN SYSTEM IS ENERGIZED.

**Probable Cause:** Incorrect electrical power source.

**Correction:** Power supply must be a minimum of 12 VDC. Recommended power source if from the key switch "on" position. Ensure that power is not taken from a source with an additional on/off switch, i.e., light switch. Make sure wiring is in accordance with Jacobs installation manual for brake model.

**Probable Cause:** Low engine oil pressure.

**Correction:** Determine oil pressure at engine brakes using procedures given in this manual (see Section 1.2 for oil pressure requirements). If oil pressure is below specifications, engine should be repaired in accordance with manufacturers' procedures.

## Problem: Engine brake activates with switches open (off)

**Probable Cause:** Center solenoid valve seal ring damaged.

**Correction:** Remove solenoid. Replace all seal rings.

**Probable Cause:** Engine brake improperly wired.

**Correction:** Check wiring in accordance with Jacobs wiring diagrams.

## Problem: Engine brake slow to operate or weak in effect

**Probable Cause:** Lube oil cold and thick.

**Correction:** Allow engine to warm before operating brakes.

**Probable Cause:** Improper slave piston adjustment or slave piston binding in bore.

**Correction:** Readjust in accordance with Jacobs procedures for model brake in question. Ensure that slave piston responds smoothly to the adjusting screw by loosening jam nut and screwing the screw through its full travel for full slave piston motion. Make sure piston travels full range without binding or sticking.



REMOVE SLAVE PISTON CAREFULLY WHEN  
DISASSEMBLY IS NECESSARY. USE EITHER  
THE JACOBS SLAVE PISTON REMOVAL TOOL  
OR AN ARBOR PRESS. SLAVE PISTON  
SPRINGS ARE UNDER HEAVY COMPRESSION.

**Probable Cause:** Lower solenoid seal damaged, allowing oil to exit housing.

**Correction:** Remove solenoid valve and replace all seal rings.

**Probable Cause:** Solenoid screen clogged, stopping supply of oil to brake.

**Correction:** Remove solenoid valve and clean or replace screen.

## Problem: Engine brake slow to operate or weak in effect (cont.)

**Probable Cause:** Master piston not moving in bore.

**Correction:** Inspect master piston and bore for scoring or burrs. If any present, clean surface with crocus cloth. If unable to remove burrs, replace piston or housing. Inspect lube oil for signs of contaminants. If any are present, replace oil and filters and correct cause of contamination.

**Probable Cause:** Control valves binding in housing bore.

**Correction:** Remove control valve. If body is scored, replace control valve. Check for contaminants in lube oil. Clean housing and control valve. If binding continues, replace housing.

**Probable Cause:** Control valve defective.

**Correction:** Remove control valve. Make sure check ball is seated in bore and can be moved off seat. Make sure there is spring pressure against ball. Flush in cleaning solvent. Replace if necessary.

**Probable Cause:** Switch operation sluggish. Check dash switches, clutch switch, throttle switch.

**Correction:** Readjust or replace switch. Check throttle or clutch return springs for proper operation. On 71/92A, ensure engine is going to "no fuel" position and governor riser bearing is allowing free governor operation.

**Probable Cause:** Solenoid valve operation erratic

**Correction:** Check solenoid valve using electrical specifications explained in this manual or, with key on, brake switches on, and engine off, activate solenoid electrically. Ensure solenoid cap depresses



DO NOT TOUCH ELECTRICAL CONNECTION  
WHEN SYSTEM IS ENERGIZED.

**Probable Cause:** Engine brake housing plugs leaking.

**Correction:** Check plugs for signs of leaks. If leaks are present, remove plug, clean threads and install at 100 lb.-in. (11 N·m) torque. Use Jacobs plugs.

**Probable Cause:** Outer control valve spring broken, or engine oil pressure extremely high (see Section 1.2).

**Correction:** Outer control valve spring broken, allowing control valve to over-index. Problem is engine lube system. Consult appropriate engine repair manual for causes of high lube oil pressure.

## Problem: Oil pressure dropping below minimum required for engine brake operation

**Probable Cause:** Upper solenoid seal ring damaged.

**Correction:** Remove solenoid. Inspect seal ring and replace all seal rings.

**Probable Cause:** Damaged oil supply seals under or between housings.

**Correction:** Remove housing and replace seals. Inspect for cracked or broken oil connectors, replace seals.

**Probable Cause:** Aeration of lubricating oil.

**Correction:** Check for aeration of the oil. Activate, then deactivate engine brake. Watch escape oil coming from control valve cover. If oil has bubbles or if foamy, air is present in system. Aeration can be caused by the crankcase being too full of oil or not enough oil being present in the crankcase, a crack in the oil pickup tube or leaks in the oil suction tube or hose. Correct in accordance with manufacturer's procedures.

**Probable Cause:** Lubricating oil being diluted by fuel oil.

**Correction:** Have an oil analysis of lube oil to determine if fuel is present. Correct per engine manufacturer's procedures.

**Probable Cause:** Low engine oil level.

**Correction:** Consult engine manual for specifications. Add oil or re-calibrate dipstick as required.

**Probable Cause:** Worn engine rocker lever bushings.

**Correction:** Replace bushings in accordance with engine manufacturer's procedures.

**Probable Cause:** Oil leaking from around cylinder head.

**Correction:** Repair causes of leaks.

**Probable Cause:** Restrictions in the oil passages leading to engine brake.

**Correction:** Inspect all the passageways, remove any items restricting oil flow.

**Probable Cause:** Models 401, 404 and 760 only (not 760A or 765). Check ball valve assembled inversely or more than one spring is used.

**Correction:** Remove check ball valve. Check number of springs used. Reassemble, using one spring, in the following order:

Model 401: First insert the spring, then the ball, washer and retaining ring.

Models 404 and 760: First insert the ball, then the spring and plug.

---

## **Problem: One or more cylinders fail to stop braking or engine stalls.**

**Probable Cause:** Control valve inner spring broken.

**Correction:** Replace inner spring.

**Probable Cause:** One or more control valves stuck in "on" or up position.

**Correction:** Check control valves for binding. Remove and clean or replace if necessary. Inspect lube oil for contaminants.

**Probable Cause:** Solenoid valve sticking in "on" position.

**Correction:** If solenoid valve cap remains down with no electric current being supplied, replace solenoid valve.

**Probable Cause:** Center solenoid seal ring damaged. Allows oil to enter brake with solenoid valve closed.

**Correction:** Remove solenoid and replace all seal rings.

**Probable Cause:** Solenoid valve exhaust plugged.

**Correction:** Remove any restrictions at exhaust (bottom) of solenoid valve.

**Probable Cause:** Clutch switch or throttle switch stuck in "on" position or out of adjustment.

**Correction:** Check for proper operation. Readjust or replace as needed.

## **Problem: Engine misses or loses power.**

**Probable Cause:** Slave piston adjustment too tight.

**Correction:** Readjust slave piston clearance in accordance with appropriate Jacobs installation manual.

**Probable Cause:** Insufficient clearance between exhaust crosshead and underside of exhaust rocker lever (Cummins engine applications only).

**Correction:** Pass a 0.020" wire gage between back section of crosshead and underside of rocker lever. If 0.020" clearance cannot be obtained, change crosshead with another cylinder and re-measure. If clearance still cannot be obtained, check for bent crosshead guide pin or enlarged rocker lever. Replace as required.

**Probable Cause:** Auto-Lash® plunger in full extended position (Cummins engine applications only).

**Correction:** Check for over-torque of locknut. Re-torque to 25 lb.-ft. maximum. If condition continues, replace Auto-Lash.

## **Problem: Sudden drop in engine lube oil pressure.**

**Probable Cause:** Oil inlet supply seal missing or damaged.

**Correction:** Replace seal.

**Probable Cause:** Upper solenoid valve seal missing or damaged.

**Correction:** Remove solenoid and replace upper seal ring.

**Probable Cause:** Models 71/92 and 53A, rapid dilution of lube oil caused by loose or cracked fuel pipes.

**Correction:** Inspect fuel pipes for proper torque (10 lb.-ft.) or cracks at flare ends. Start engine. Pressure check heads for signs of more pipe leakage. Replace any showing signs of leakage.

**Probable Cause:** External oil supply hoses or fittings cracked and leaking.

**Correction:** Inspect all hoses and fittings for tightness, chafes or cuts. Replace or repair as necessary.

**Probable Cause:** Oil connectors between housings (where applicable) broken or leaking.

**Correction:** Inspect all oil connectors for cracks and broken or loose screws. Look for missing seals and seals that are brittle split or damaged. Replace as required.

# 1.4 Engine Brakes for Cummins Engines

## Two-valve Design

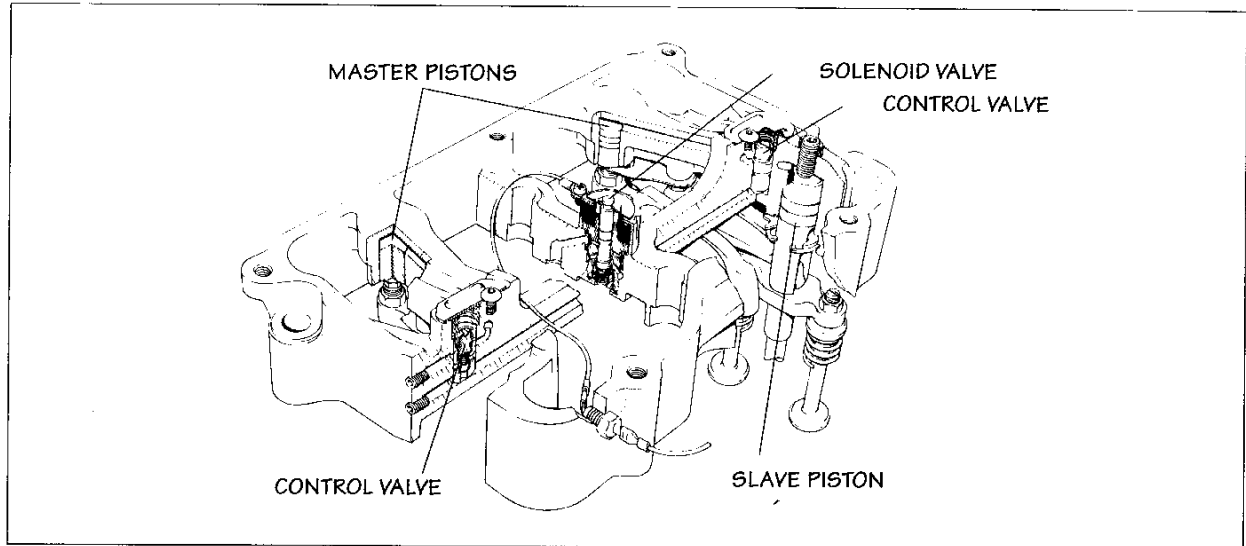

FIG. 1.4.1

## Current Production Models

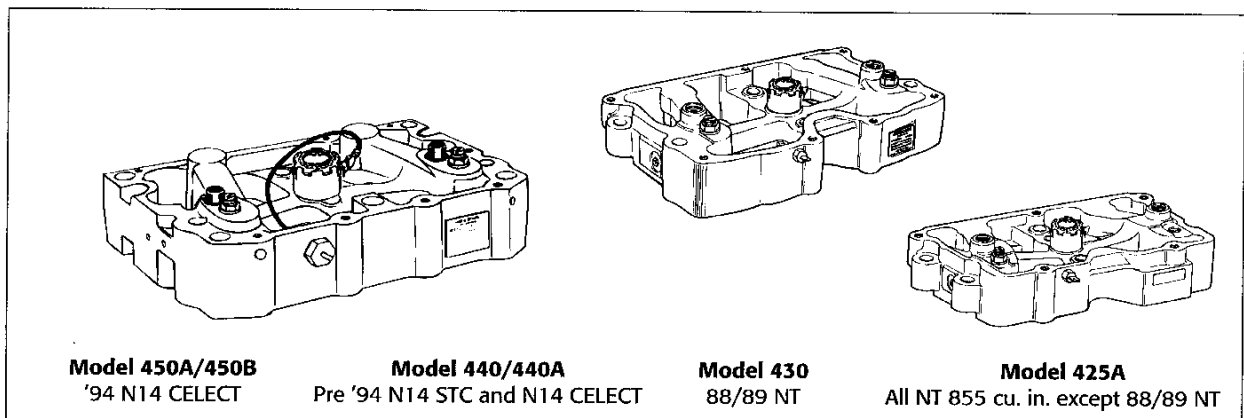

Fig. 1.4.2

Former engine brake models for Cummins NT-855 cu. in. engine applications:

25	25B	30	30E
30 SN (Spray Nozzle)	400	400H	

The former Models 401A/B/C single-valve design were also used for Cummins 855 CID engines (see Page 1.4.3).

For proper application information, refer to your nearest Jacobs Warehouse Distributor or your Jacobs Field Representative.

# Special Features

**Auto-Lash®:** Used in Jacobs Engine Brakes for Cummins Engines with two-valve operation only.

The Auto-Lash adjusting screws are designed to provide optimum exhaust valve opening during engine brake operation. Each engine brake model uses a different Auto-Lash; the distinguishing feature is the amount of plunger protrusion. The plunger protrusion amount is directly related to engine brake timing advancement.

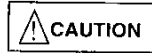

AUTO-LASHES CANNOT BE INTERMIXED.

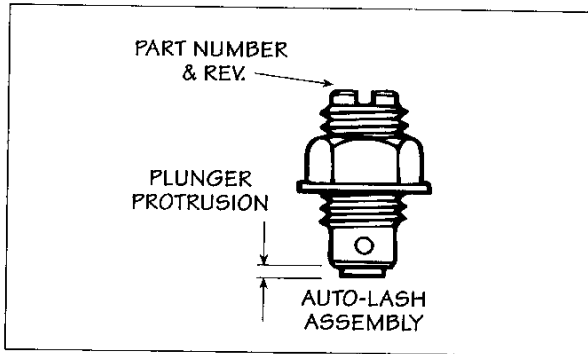

FIG. 1.4.3

## Part Number Identification & Matrix

Refer to specific engine brake model parts manual for proper Auto-Lash.

## Operation (example only)

Engine brake in "OFF" mode. Static setting of 0.018" clearance for normal engine operation (see Fig. 1.4.4).

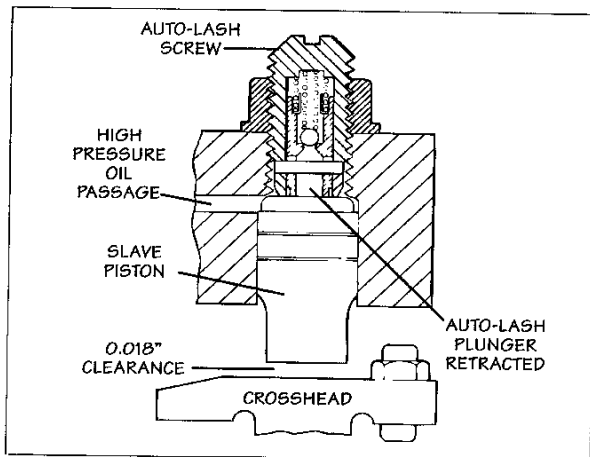

FIG. 1.4.4

Engine brake in "OPERATING" mode. Clearance of 0.009" for more valve opening.

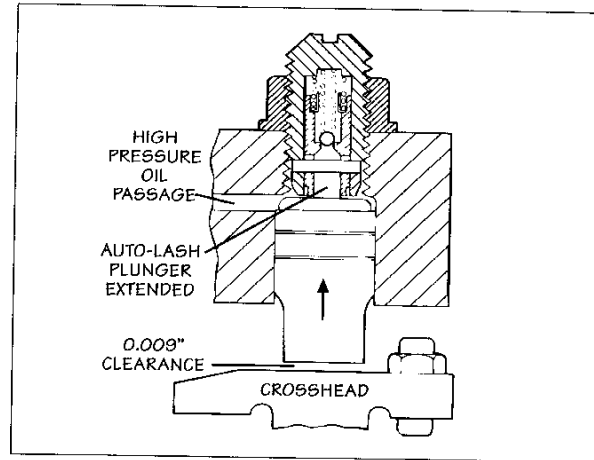

FIG. 1.4.5

During engine brake operation, the spring inside the Auto-Lash assembly moves the plunger out to its fullest extension (see Fig. 1.4.5). Oil under pressure enters the Auto-Lash body through the hole in the plunger and "locks" the plunger in its extended position. This reduces the slave piston clearance from 0.018" to 0.009" (Model 400 Auto-Lash example).

Slave piston travel provides optimum exhaust valve opening for most effective engine brake operation for this engine/engine brake combination (see Fig. 1.4.6).

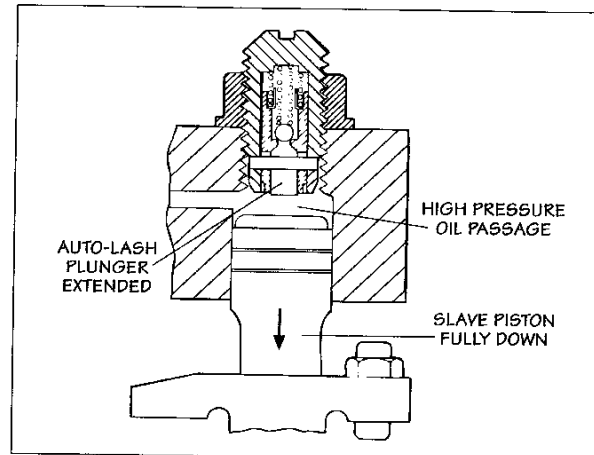

FIG. 1.4.6

When the engine brake is shut off, the oil bleeds off and the plunger retracts from the force of the slave piston spring. The slave piston clearance returns to 0.018" for normal engine operation (see Fig. 1.4.4).

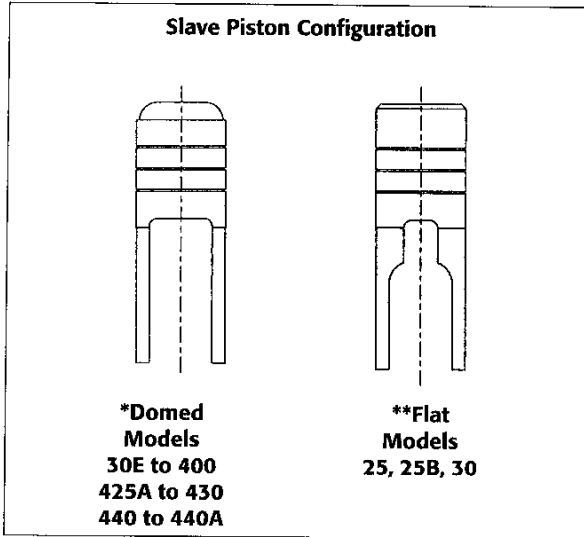

FIG. 1.4.7

**Short Slave Piston Part Numbers for  
Reworked Cylinder Heads and Exhaust Valves**

	Domed*	Flat**	425A	430	440/ 440A
Stand.	007623	001484	017409	014864	017409
Short	007696	001486	017728	017078	017728

Short slave pistons may be required where cylinder heads and exhaust valves have been reworked. Valve stems may protrude too high above cylinder head to allow for sufficient slave piston-to-crosshead clearance

# Single-valve Design

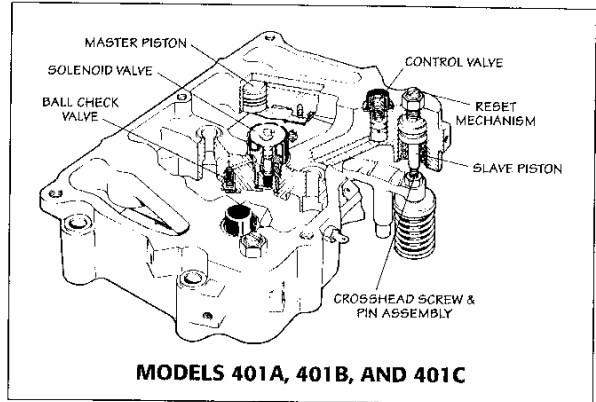

FIG. 1.4.8

Some early model engine brakes for 855 CID engines used a single-valve operating system. Only one exhaust valve per cylinder is opened during engine braking. The two-valve operation opens two exhaust valves.

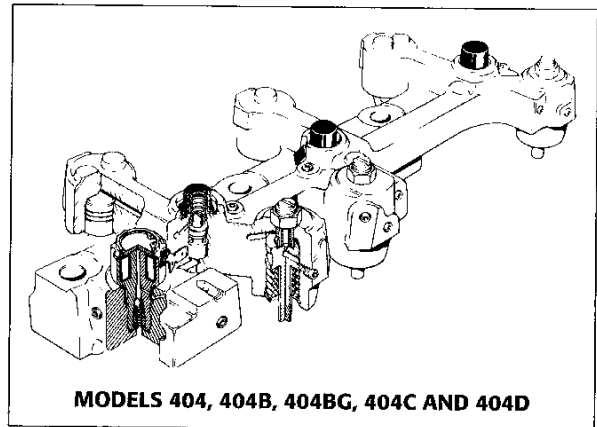

FIG. 1.4.9

The major difference between the brake models is the diameter of the master piston. Neither the master pistons nor the housings are interchangeable.

Model	Master Piston Diameter
401A	0.938"
401B	0.875"
401C	1.000"
404	0.875"
404B	0.875"
404BG	0.875"
404C	0.6875"
404D	0.6875"

## Special Features

### Guideless Crossheads

All 91L10 and later engines use guideless crossheads (Fig. 1.4.10).

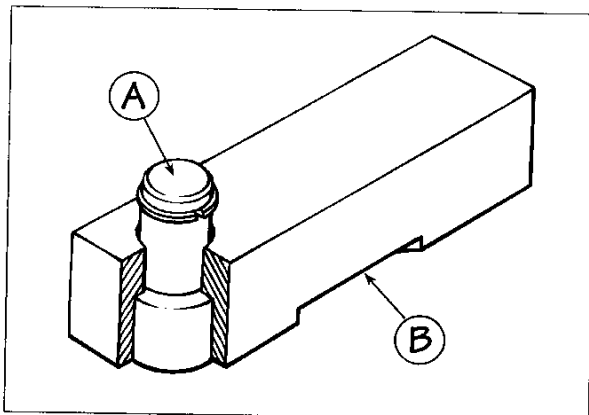
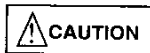

FIG. 1.4.10

A. Jacobs retained actuator pin

B. Jacobs guideless crosshead assembly



DO NOT DISASSEMBLE THE ACTUATOR PIN FROM THE JACOBS CROSSHEAD. THE ASSEMBLY IS MADE UP OF MATCHED PARTS AND MUST NOT BE FIELD SERVICED.

Lubricate the actuator pins and valve stems with engine oil and install the Jacobs crossheads over the exhaust valves. Locate the actuator pins on the exhaust valves closest to the rocker shaft.

The crosshead should move freely from side to side, pivoting on the side without the actuator pin. No adjustment is required with guideless crossheads.

### Crosshead Screw and Pin Assembly

The crosshead pin assembly is a key component in the single-valve system. The pin assembly allows for only one valve to be opened by the engine brake slave piston. It allows for the re-use of the Cummins exhaust crosshead, simplifying installation. The pin assembly replaces the Cummins crosshead adjusting screw and nut and can be adjusted using Cummins procedures. The pin assembly requires no specific maintenance.

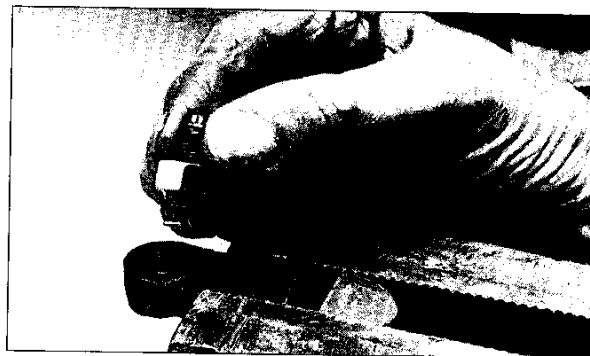

FIG. 1.4.11

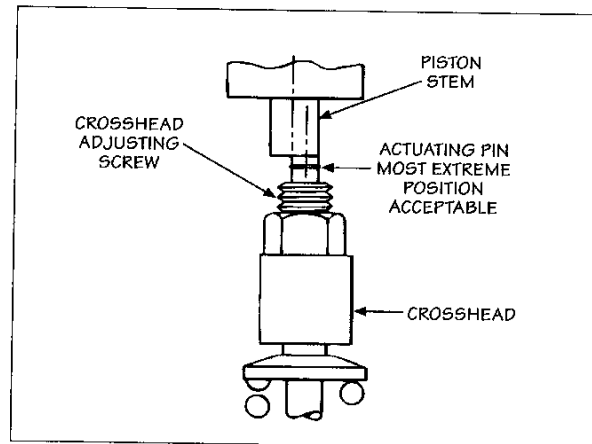

FIG. 1.4.12

### Check Ball Valve: Used in Models 401 and 404

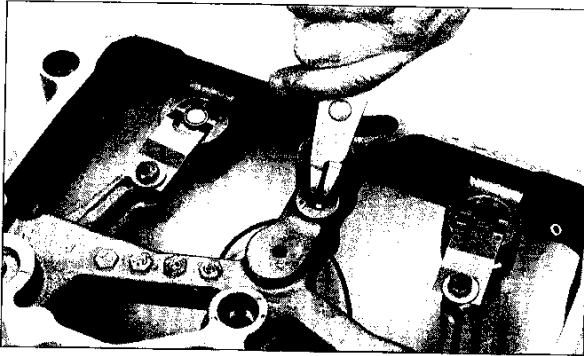

FIG. 1.4.13

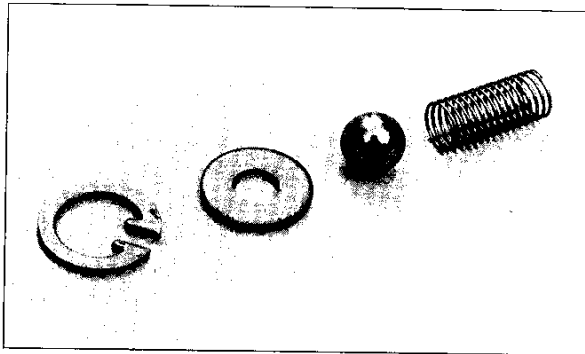

FIG. 1.4.14

The check ball mechanism in the single-valve engine brake is used to prevent the high-pressure oil that is passing through the slave piston drillings from leaving the engine brake housing. If the oil did escape from the housing, the normal engine oil supply would be insufficient to make up the loss of oil and the engine brake performance would be greatly reduced.

During reassembly, pay special attention to the proper sequence of reinstalled parts and make sure that the proper parts are used.

### Reset Mechanism: Used in Models 401 and 404

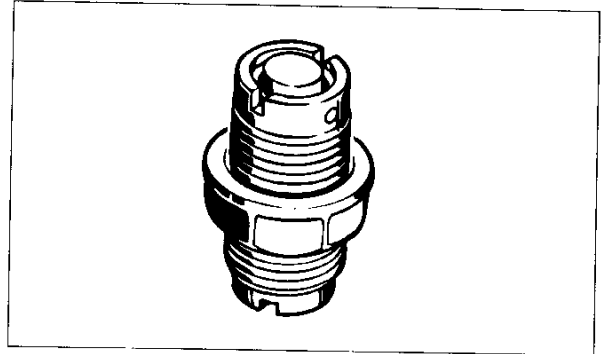

FIG. 1.4.15

The purpose of the reset mechanism is (1) to allow the opening of a single exhaust valve during engine brake operation; and (2) after the energy is released from the cylinder, to close the exhaust valve that was open before the normal exhaust rocker motion begins. This prevents excessive side loading on the engine's crosshead guide pin.

#### Reset Design

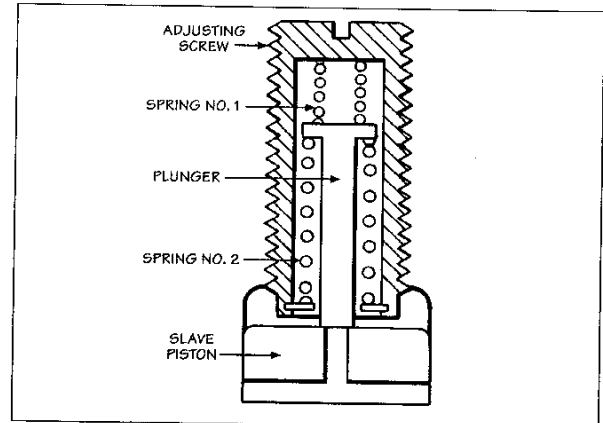

FIG. 1.4.16

The main components are the screw body, the plunger and two springs. Spring #1, on top of the plunger, holds the plunger lightly against the slave piston upper hold, preventing the oil from flowing out too early in the engine brake cycle. Spring #2 pops the plunger off the slave piston when the reset mechanism activates. This uncovers the upper slave piston hole and allows the oil to flow to the bottom of the control valve bore.



## Reset Operation

Initially, the top spring holds the reset plunger against the slave piston and covers a hole in the top of the slave piston. When the engine brake is activated and engine oil pressure moves the master piston down against the injector adjusting screw, the rocker upward motion starts building high hydraulic pressure in the engine brake high-pressure circuit. The slave piston moves down against the Jacobs crosshead pin assembly and the engine exhaust valve stem. The oil in the housing high-pressure circuit build pressure rapidly, producing the force required to open the exhaust valve.

Since the area above the reset plunger is greater than the area under it, the plunger is forced down with the slave piston, keeping the top hole sealed.

As the slave piston moves down on the exhaust valve stem, the reset plunger follows the slave piston and compresses Spring #2. At this time, the high oil pressure above the reset plunger is greater than pressure from Spring #2, and the plunger continues following the slave piston.

When the exhaust valve is opened and the compressed air leaves the cylinder, the high pressure in the housing drops rapidly. When the oil pressure drops below the force of Spring #2, the spring forces the plunger back into the screw body and the hole in the top of the slave piston is uncovered. The oil passes through the hole in the top of the slave piston, out through the crosshole and into the passage to the bottom of the control valve bore. Since this oil is still at a relatively high pressure, it moves the control valve upward. This reduces the pressure to nearly that of low-pressure supply oil.

With oil pressure reduced, the slave piston springs return the slave piston to the start position and the engine exhaust valve closes. The engine valve is closed before normal engine exhaust motion begins. The engine exhaust rocker pushes against the crosshead with both exhaust valves opening together.

The engine brake is now ready for another cycle.

### Short Slave Piston Part Numbers for Reworked Cylinder Heads and Exhaust Valves

	401	404/BG/C/D	404 - 404BG
Standard	009439	016774	011377
Short	012397	017260	012419

Short slave pistons may be required where cylinder heads and exhaust valves have been reworked. Valve stems may protrude too high above cylinder head to allow for sufficient clearance between slave piston and crosshead screw and pin assembly.

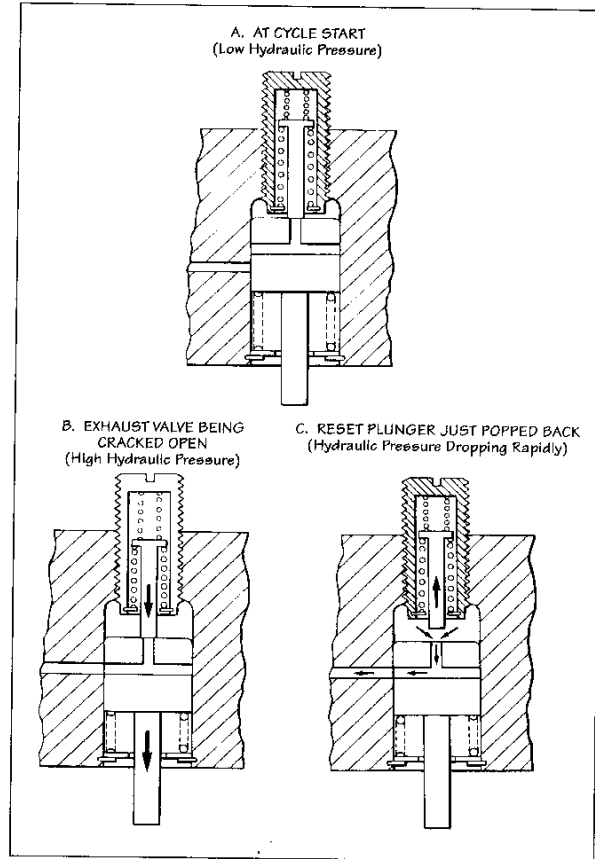

FIG. 1.4.17

# 1.5 Engine Brakes for Caterpillar Engines

## Model 346D

The Model 346D Jake Brake Engine Retarder is designed and approved for use on all Caterpillar engines: 3406, 3406B and 3406C (with an serial number of 5KJ07800 and above or with an engine serial number of 3ZJ16182 and above). The Model 346D replaces the former Models C346, C346A, C346B and C346C.

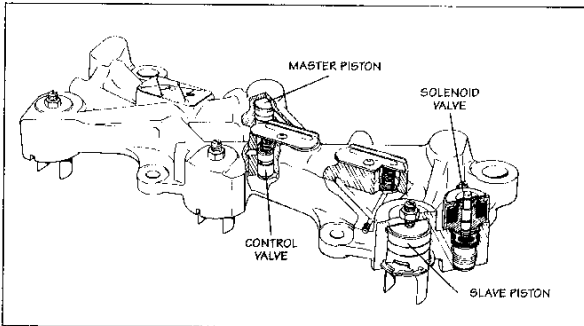

FIG. 1.5.1

### Master-Slave Circuit Relationship Listed in Engine Firing Order

Location of Master Piston	Location of Slave Piston
<b>Actuates</b>	
No. 1 Pushrod	No. 3 Exhaust Valve
No. 5 Pushrod	No. 6 Exhaust Valve
No. 3 Pushrod	No. 2 Exhaust Valve
No. 6 Pushrod	No. 4 Exhaust Valve
No. 2 Pushrod	No. 1 Exhaust Valve
No. 4 Pushrod	No. 5 Exhaust Valve

CHART 1

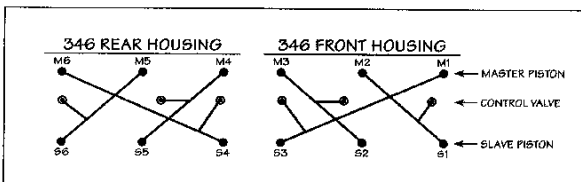

CHART 2

## Special Features

### Exhaust Rocker Adjusting Screw

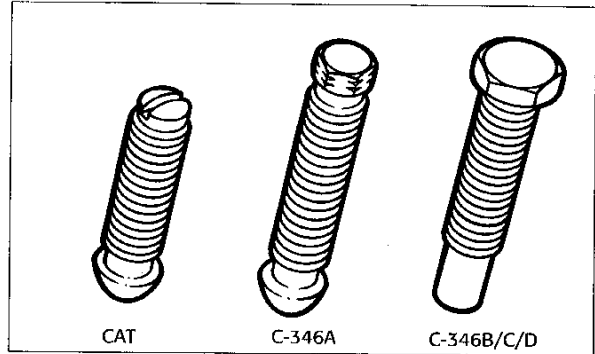

FIG. 1.5.2

The large headed screws can be used with C346A and C346 housings. If large-headed screws are used on C346A and C346 housings, Model C346B/C/D master piston return springs must also be used. See parts manual for part numbers.

### Slave Piston Adjusting Screw

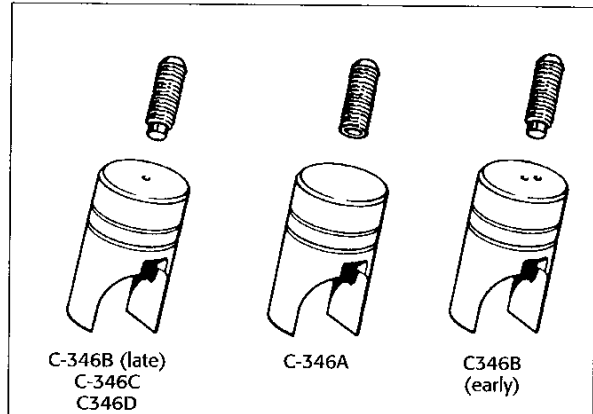

FIG. 1.5.3

The Models C346 and C346B use an adjusting screw with a spring loaded valve at the slave piston end. Note that the adjusting screws are different and have different part numbers and are not interchangeable. The adjusting screw valve seals the center hole in the slave piston during engine brake operation. The piston used in the early production C346B also has a 0.025" (0.64 mm) diameter bleed hole located to the side of the center hole.

The Model C346A uses a solid adjusting screw and a solid slave piston (**no hole through the top**).

**NOTE:**

IT IS RECOMMENDED THAT C346A HOUSING BE CONVERTED TO INCLUDE NEW ADJUSTING SCREWS AND SLAVE PISTONS. THESE PARTS ARE ONES CURRENTLY USED IN C346D HOUSINGS.

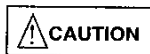

SOLID ADJUSTING SCREWS MUST NOT BE USED IN MODEL C346, C346B, 346C AND 346D HOUSINGS BECAUSE THE HOLE IN THE TOP OF THE SLAVE PISTON WILL NOT BE SEALED AND ENGINE BRAKING WILL BE LOST. EXCESS OIL WILL BE SPILLED IN THE OVERHEAD.

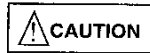

DO NOT TAMPER WITH THE ADJUSTING SCREW ASSEMBLY. ENGINE DAMAGE COULD RESULT.

**NOTE:**

FOR C346B APPLICATIONS, A "B+ UPGRADE KIT" CAN BE INSTALLED TO IMPROVE RETARDING PERFORMANCE. SEE A JACOBS DISTRIBUTOR OR DEALER FOR DETAILS.

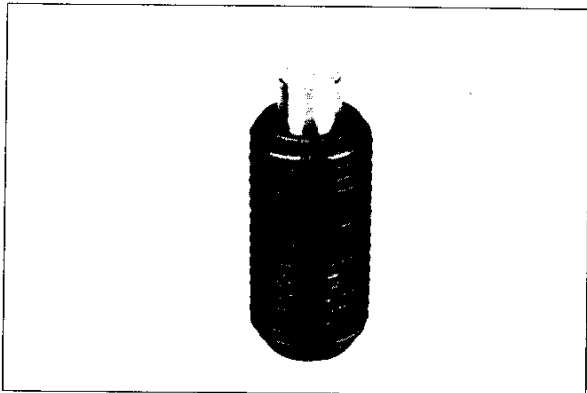

FIG. 1.5.4

# Model 349A

The Model 349A Jake Brake Engine Retarder is designed and approved for use on Caterpillar 3406B ATAAC (Air-to-Air After-cooled) engines with PEEC or mechanical fuel controls. The Model 349A replaces the former Model 349.

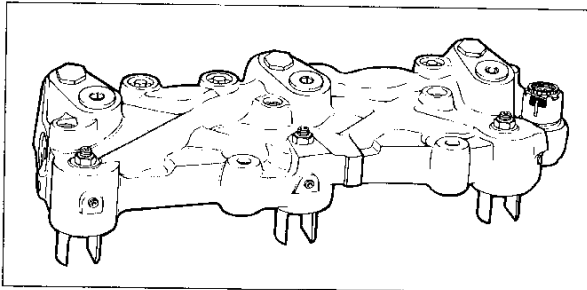
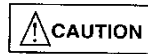

FIG. 1.5.5



THE MODEL 349A IS NOT TO BE INSTALLED ON 3406B ENGINES WITH SERIAL NUMBERS LOWER THAN 7FB39279 OR ANY 3406 ENGINES WITH THE 92U SERIAL NUMBER PREFIX.

## Master-Slave Circuit Relationship Listed in Engine Firing Order

Location of Master Piston	Location of Slave Piston
<b>Actuates</b>	
No. 1 Pushrod	No. 3 Exhaust Valve
No. 5 Pushrod	No. 6 Exhaust Valve
No. 3 Pushrod	No. 2 Exhaust Valve
No. 6 Pushrod	No. 4 Exhaust Valve
No. 2 Pushrod	No. 1 Exhaust Valve
No. 4 Pushrod	No. 5 Exhaust Valve

CHART 3

## Model 349A Operating Schematic

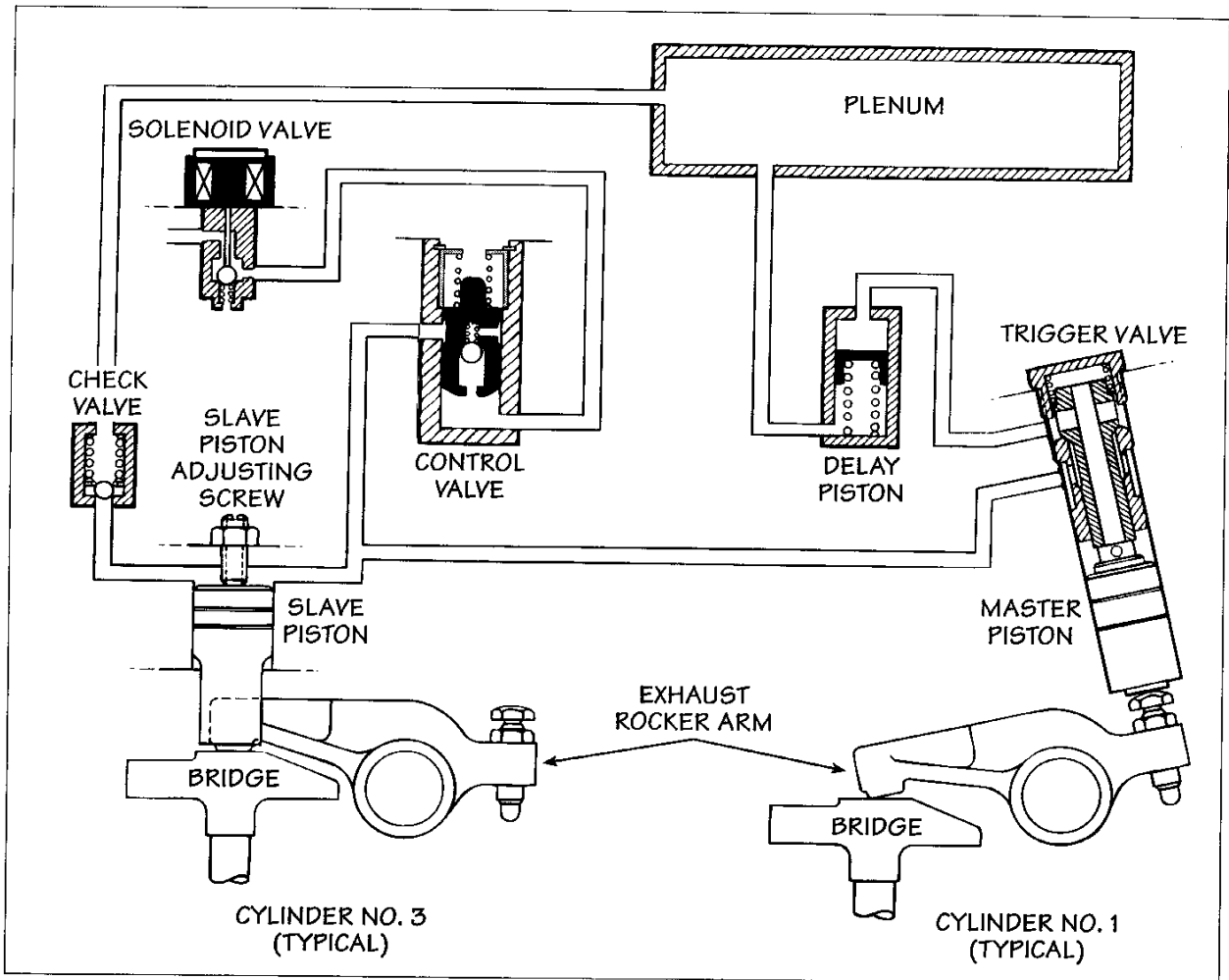

FIG. 1.5.6

## Exhaust Blowdown

The braking cycle is accomplished by utilizing the pushrod motion of an exhaust valve of another cylinder during its normal exhaust cycle. Referring to the chart above, Cylinder No. 1 exhaust pushrod opens the exhaust valves of Cylinder No. 3 in this sequence:

1. The energized solenoid valve permits engine lube oil to flow under pressure through the control valve to both the master piston and the slave piston.
2. Oil pressure causes the master piston to move down, coming to rest on the corresponding exhaust rocker arm adjusting screw. See the accompanying chart for master/slave operation relationship.
3. The exhaust rocker pushrod begins upward travel (as in normal exhaust cycle) forcing the master piston upward and creating a high pressure oil flow to the delay piston.
4. The delay piston moves and compresses the plenum oil to high pressure. The delay piston and plenum act as a high pressure "spring" to activate the slave piston at the appropriate time.
5. The master piston continues moving upward and at the appropriate time, opens the trigger valve.
6. High pressure oil flows from the delay piston through the trigger valve to the slave piston.
7. The slave piston moves down, contacts the exhaust valve bridge and opens the exhaust valves releasing compressed cylinder air to the exhaust manifold.
8. Compressed air escapes to atmosphere, and energy spent compressing air is lost, providing retarding power.
9. The master piston moves down, the slave piston retracts and the trigger resets, completing the compression braking cycle.

## Slave Piston Adjustment

For correct slave piston adjustment procedures and settings, refer to specific installation manual and current service publications.

## Trigger Valve Adjustment

NOTE:

REMOVE TRIGGER CAPS AND SPRINGS FROM ALL CYLINDERS BEFORE ADJUSTING TRIGGER.

Trigger valve travel adjustment is set according to the settings shown in the following chart:

### Trigger Adjustment

Cylinder No.	Pre-1991 Model Year	1991 and later Model Year	
		3406B and 3406C 400 HP	All Others
1	0.100"	0.130"	0.100"
2, 3, 4, 5, 6	0.100"	0.095"	0.100"

All adjustments are  $\pm 0.003$ "

CHART 4

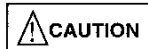

CYLINDER NO. 1 TRIGGER VALVE SETTING ON 1991 AND LATER MODEL YEAR ENGINES WITH 400 HORSEPOWER IS DIFFERENT THAN FOR THE OTHER CYLINDERS ON THAT ENGINE.

NOTE:

TRIGGER VALVE ADJUSTMENT AS WELL AS SLAVE PISTON ADJUSTMENT MUST BE MADE ANY TIME THE BRAKE HOUSINGS ARE REMOVED AND REPLACED.

After the engine valves and slave pistons are adjusted on all cylinders, the trigger valves should be adjusted using the trigger adjusting group shown in Fig. 1.5.7.

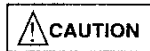

MAKE THIS ADJUSTMENT CAREFULLY AND ACCURATELY TO ASSURE MAXIMUM ENGINE BRAKE PERFORMANCE AND TO PREVENT POSSIBLE ENGINE DAMAGE. THE JACOBS TRIGGER ADJUSTMENT GROUP IS REQUIRED FOR THIS ADJUSTMENT.

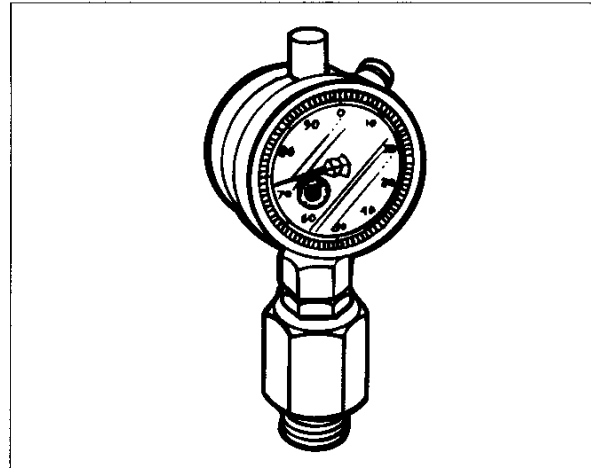

FIG. 1.5.7

1. Remove trigger caps and springs from ALL cylinders before adjusting the trigger. Do not remove trigger valve (see Fig. 1.5.8).

The first trigger adjustment should be made on the cylinder last adjusted for slave piston lash.



FIG. 1.5.8

2. Install the dial indicator assembly into the trigger valve bore (see Fig. 1.5.9). Hand tighten, metal to metal contact only.

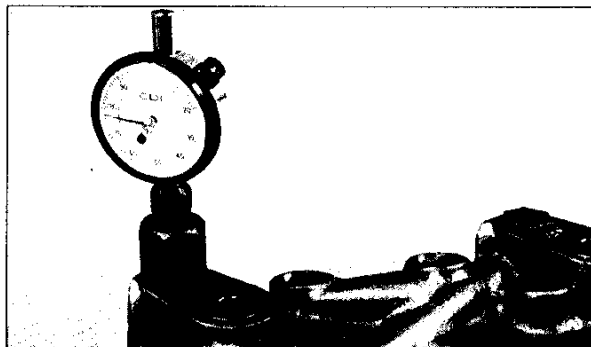

FIG. 1.5.9

Indicator extension will contact the trigger valve and push the master piston down slightly (see Fig. 1.5.10).

NOTE:

THE MASTER PISTON MUST NOT COME IN CONTACT WITH THE EXHAUST ROCKER ADJUSTING SCREW AT THIS TIME.

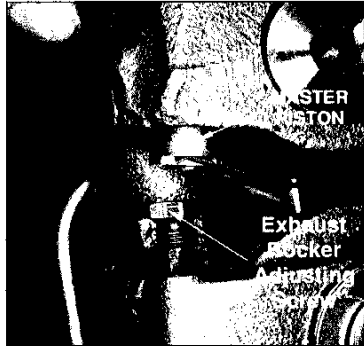

FIG. 1.5.10

3. Set the indicator to zero.
4. Rotate the engine crankshaft slowly in the direction of rotation. The exhaust rocker adjusting screw will contact the master piston and the dial indicator needle will begin to move. Record the maximum travel of the indicator.

**Travel must be set according to Trigger Adjustment Chart (Chart 3) on page 1.5.4.**

5. Use the following procedure to adjust the trigger travel. The indicator travel must be within  $\pm 0.003''$  of specific trigger adjustment as shown in the chart on page 1.5.4.

If necessary to further adjust trigger travel:

- A. Remove the dial indicator/adaptor assembly and insert a long  $5/32''$  hex key wrench through the trigger valve bore and into the master piston assembly (see Fig. 1.5.11).



FIG. 1.5.11

- B. Insert the Jacobs master piston holding wedge between the master piston and exhaust rocker adjusting screw. Push the wedge in until the master piston bottoms in its bore (see Fig. 1.5.12). This will prevent the master piston from turning while the trigger adjustment is being made.

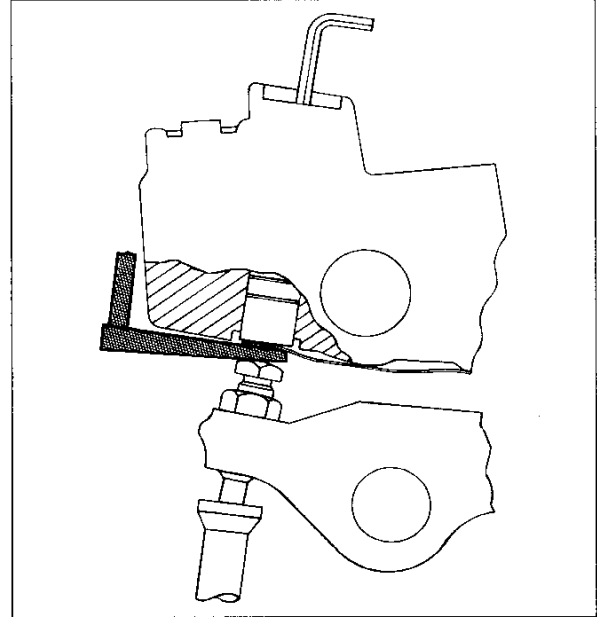

FIG. 1.5.8

- C. Push down on the hex key wrench. This unlocks the adjusting screw from the hex pin (see Figs. 1.5.13 and 1.5.14, next page).
- D. Refer to the original recorded travel found in Step 4 on previous page and adjust by pressing the hex key wrench against spring pressure. Maintain pressure while turning clockwise to decrease indicator travel or counterclockwise to increase indicator travel. Each hex ( $60^\circ$ ) equals approximately  $0.005''$  indicator (trigger) travel.

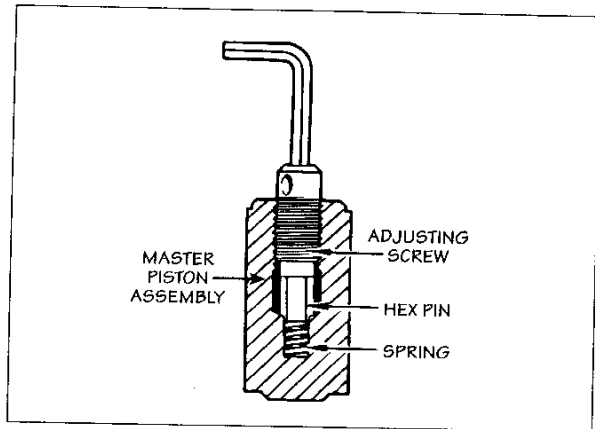

FIG. 1.5.13

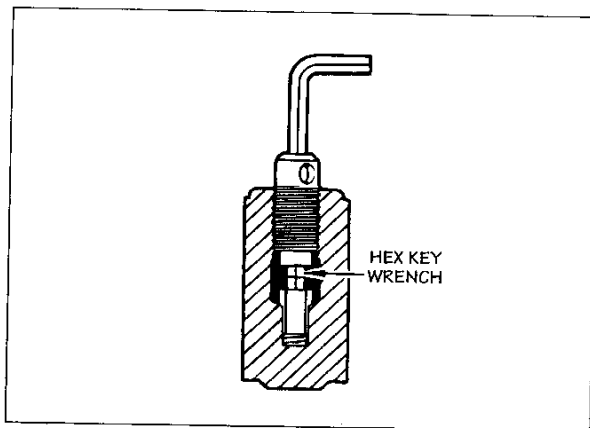

FIG. 1.5.14

- E. Remove the hex key wrench. The adjusting screw must be locked. If the adjusting screw is not locked (screw can turn), rotate the screw slightly until the hex pin snaps into the adjusting screw. The screw is now locked in position.



SPRING PRESSURE ON THE HEX PIN SHOULD LOCK THE ADJUSTING SCREW IN POSITION WHEN PRESSURE ON THE HEX KEY WRENCH IS REMOVED. IF THE SCREW IS NOT LOCKED, THE ADJUSTMENT CAN CHANGE AND POSSIBLE ENGINE OR ENGINE BRAKE DAMAGE CAN RESULT.

Reinstall dial indicator assembly. Recheck trigger travel by rotating engine crankshaft back and forth. Repeat setting procedure, if necessary.

- F. Replace trigger spring and cap. Tighten cap to 35 lb.-ft. (47 N•m).
- G. Continue adjustment of remaining cylinders in the engine firing order. Recheck torque on all six trigger caps.

# Models 317D/317E

The Model 317D Jake Brake engine retarder has been designed and approved for use on pre-1991 and 1991 model year 3176 Caterpillar engines. The Model 317D replaces Models C317, C317A and 317B.

The Model 317E Jake Brake engine retarder has been designed and approved for use on 1992 and later 3176 engine applications. The Model 317E replaces the Model 317C.

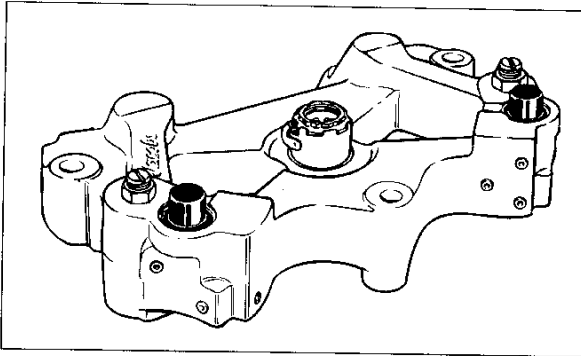

FIG. 1.5.15

## Power-Lash®

To ensure optimum exhaust valve opening during engine brake operation, a Power-Lash assembly is incorporated in the slave piston adjusting screw.

- The hole in the slave piston is sealed by a plunger in the Power-Lash. A spring holds the plunger extended for the desired travel of the slave piston (Fig. A, next page).
- When the desired travel of the slave piston and exhaust valve opening is achieved, the hole is uncovered and the high pressure oil escapes to the area below the control valve (Fig. B).
- The control valve moves up, compressing the stop (large) spring, providing a small volume of "stored" oil, ready for the next engine brake cycle. The reduced oil pressure allows the slave piston to return to its starting position, against the slave piston screw (Fig. C).

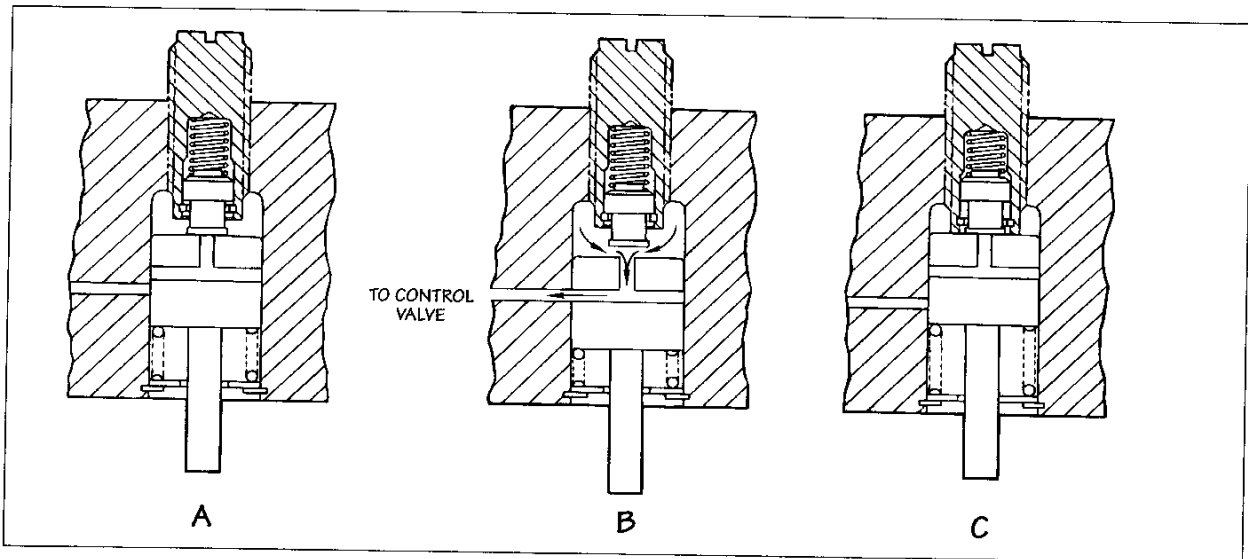

FIG. 1.5.16



# Housing Assembly Differences

## Models C317/C317A/317B/317C

Mounting methods for the C317 and C317A housings are different because of the height difference shown in Figs. 1.5.17 and 1.5.18. See brake housing installation section for specific installation procedures.

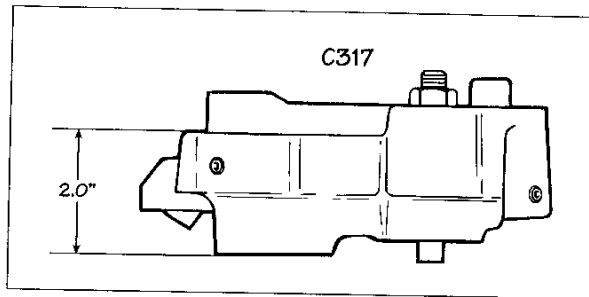

FIG. 1.5.17

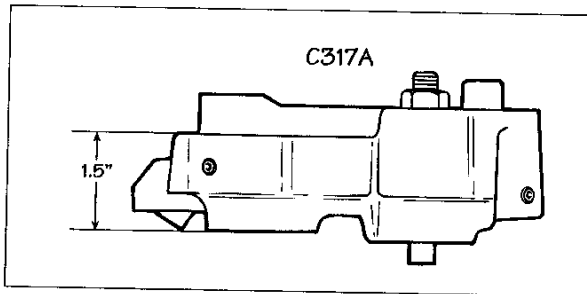

FIG. 1.5.18

The clip valve, P/N 014811, originally used with the C317 and C317A housings has been superseded by the Power-Lash™ assembly. For proper part numbers for the Power-Lash for Models C317, C317A, 317B and 317C, refer to Jacobs current parts manuals and service literature. Part numbers are located on the top of the screw body.

The master piston assembly for Models C317 and C317A is shown in Fig. 1.5.19, with the master piston assembly for Models 317B and 317C shown in the inset. Master pistons and housings are not interchangeable.

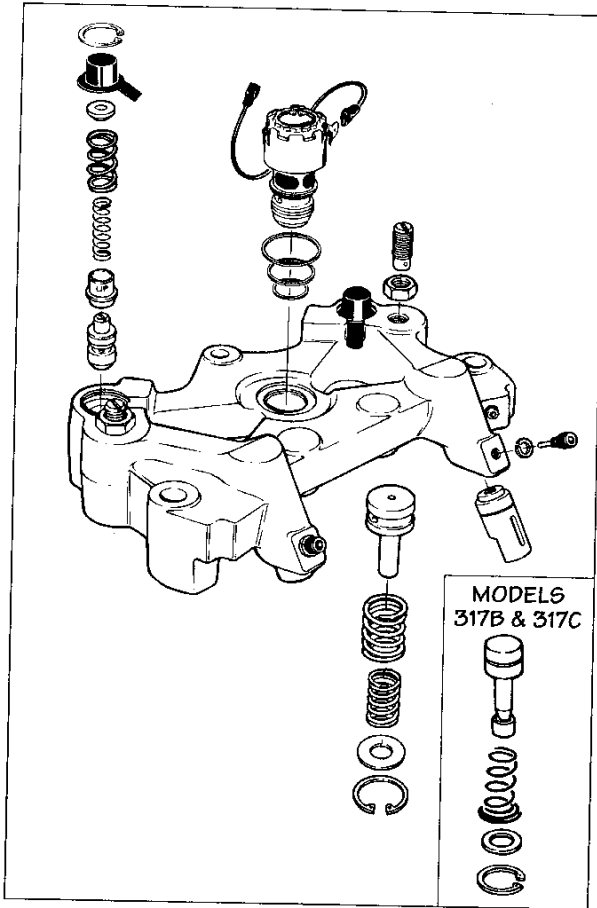

FIG. 1.5.19

### Model C317 Only

NOTE:

THE FOLLOWING SIX STEPS APPLY TO MODEL C317 HOUSINGS ONLY AND NOT TO THE C317A.

The extended stud, P/N 016088, has been replaced by bolt, P/N 014800. It is recommended that when servicing or installing the C317 engine brake, the extended stud, P/N 016088, be replaced by bolt, P/N 014800. Use the following procedure for C317 housing installation.

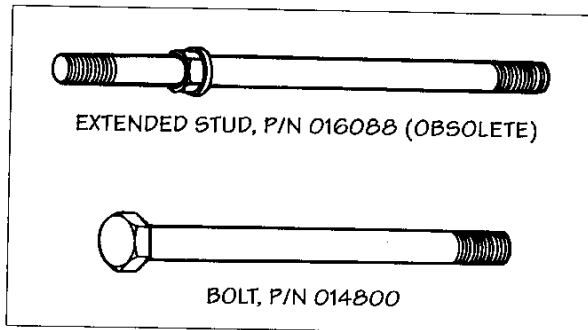

FIG. 1.5.20

NOTE:

TO ADJUST THE INJECTORS AND VALVES, THE ENGINE BRAKE HOUSINGS MUST BE REMOVED AND THE ROCKER ASSEMBLY SECURED WITH CATERPILLAR ROCKER PEDESTAL CAPSCREWS OR JACOBS P/N 014800 CAPSCREW WITH 2" SPACERS, JACOBS P/N 017535. TORQUE TO 70 LB.-FT. (9 N•M).

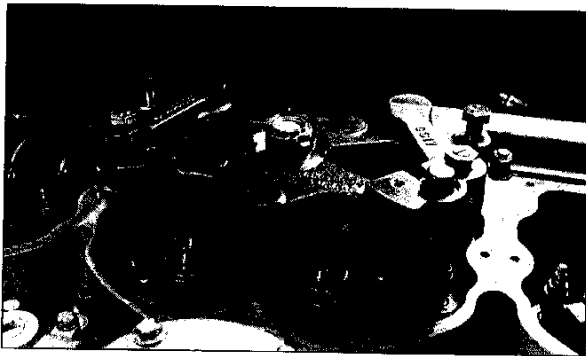

FIG. 1.5.21

1. After injectors and valves have been adjusted, remove the extended studs, or for new installations, remove the Caterpillar rocker pedestal capscrews.
2. Install the engine brake housing on the rocker pedestals.
3. Install the Jacobs bolt P/N 014800 (2 per housing) into the housing and rocker pedestals.
4. Install the Jacobs bolt through the housing into the spacer on the cylinder head bolt.

5. Tighten bolt at the rocker pedestals to 70 lb.-ft. (95 N•m).
6. Tighten the bolt at the head bolt spacer to 41 lb.-ft. (55 N•m).

### For Models C317A/317B/317C

Install the mounting stud assemblies in the rocker brackets and torque to 70 lb.-ft. (95 N•m). Adjust the injectors and valves per Caterpillar specifications.

Adjust the engine brake slave piston clearance with the valves closed to the clearance shown below:

## Slave Piston Adjustment

For correct slave piston adjustment procedures and settings, refer to specific installation manual and current service publications.

## Mounting Studs

The current mounting stud used with Model C336 and 336A housings is P/N 017156 (see Fig. 1.5.22). Bolt, P/N 016895, and spacer, P/N 012804, was previously used with the Model C336. P/N 016895 and 012804 are available as service parts.

Stud, P/N 016809, formerly used with the Model C336, has been superseded by stud, P/N 017156.

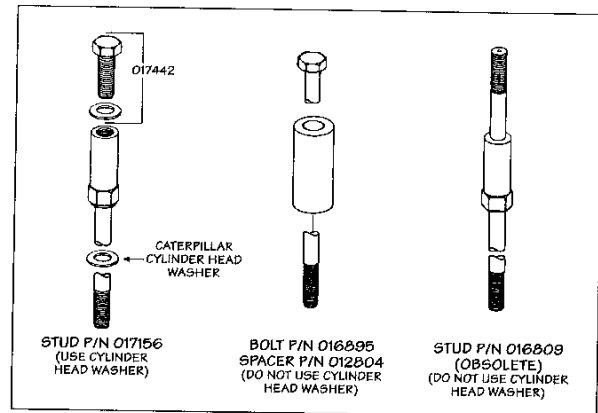

FIG. 1.5.22

# Models C336/336A

The Model C336 Jake Brake Engine Brake is approved for use on Caterpillar 3306B engines with serial numbers greater than 63Z3300 and 3306 engines with serial numbers greater than 76R6115.

The Model 336A Jake Brake Engine Brake is approved for use on Caterpillar 3306C engines with serial number 7RJ00116 or greater and Caterpillar 3306C engines with a serial number prefix of 9TL.

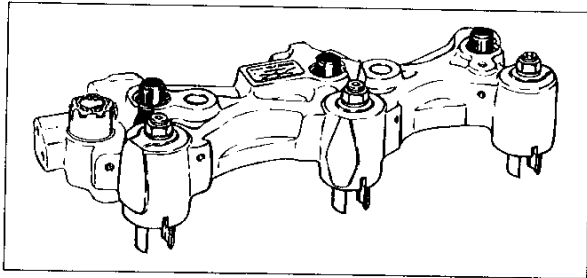

FIG. 1.5.23

## Master-Slave Circuit Relationship Listed in Engine Firing Order

Location of Master Piston	Location of Slave Piston
<b>Actuates</b>	
No. 1 Pushrod	No. 3 Exhaust Valve
No. 5 Pushrod	No. 6 Exhaust Valve
No. 3 Pushrod	No. 2 Exhaust Valve
No. 6 Pushrod	No. 4 Exhaust Valve
No. 2 Pushrod	No. 1 Exhaust Valve
No. 4 Pushrod	No. 5 Exhaust Valve

CHART 5

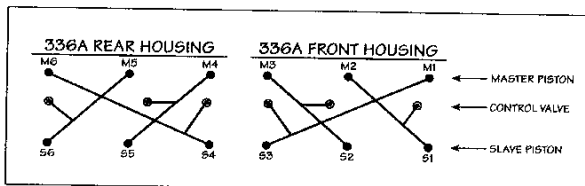
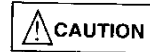

CHART 6

# Exhaust Valve Stem Caps

The valve cap shown in Fig. 1.5.24 is currently used for Models C336 and 336A engine brakes. It can be used as a replacement part, when necessary, for the former cap used with the Model C336. The valve cap shown in Fig. 1.5.25 was previously used in the Model C336 engine brake



THE VALVE CAP SHOWN IN FIG. 1.5.25 MUST NOT BE USED IN MODEL 336A ENGINE BRAKES. SERIOUS ENGINE DAMAGE MAY RESULT.

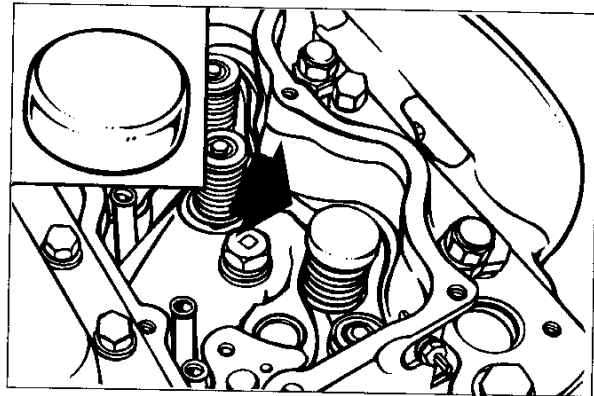

FIG. 1.5.24

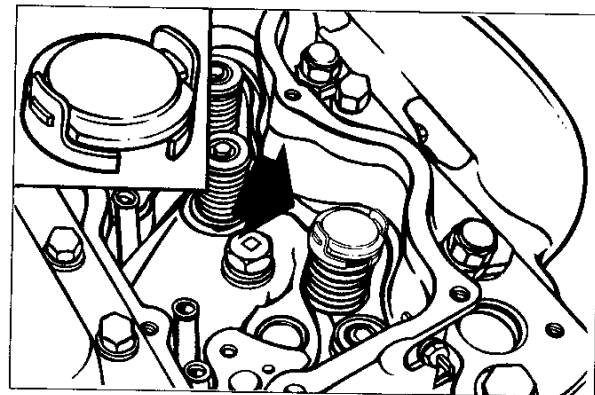

FIG. 1.5.25

# Slave Piston Clearance Settings

## Model C336 only:

The C336 uses the adjusting gage shown in Fig. 1.5.26. See Installation Manual and current service publications for slave piston clearance setting.

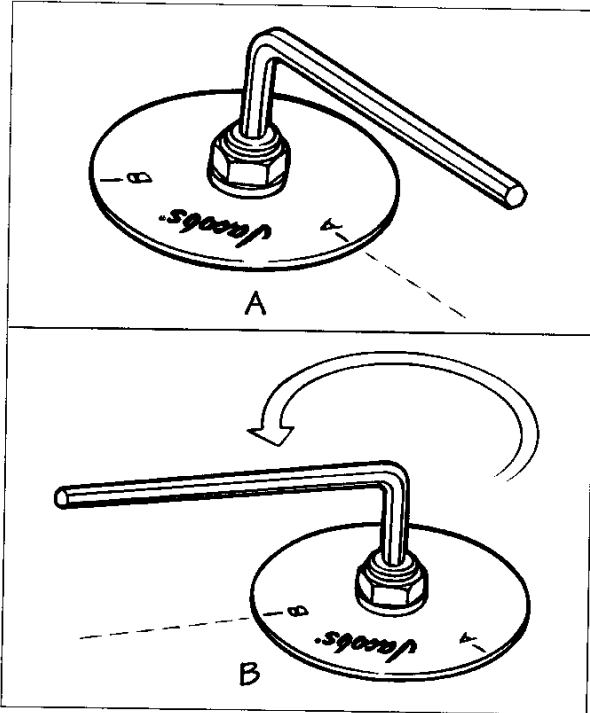

FIG. 1.5.26

## Model 336A only:

Place the Jacobs lash adjusting gage (refer to the current installation manuals for proper slave piston clearance setting) between the valve cap and slave piston foot (see Fig. 1.5.27).

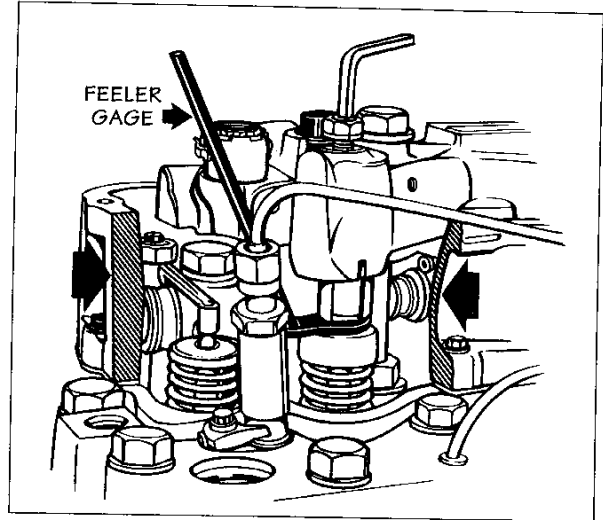
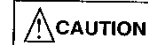

FIG. 1.5.27



BE SURE THAT THE FEELER GAGE IS FULLY ENGAGED UNDER BOTH SLAVE PISTON FEET (SEE FIG. 1.5.28). FAILURE TO PROPERLY USE TOOL MAY RESULT IN INCORRECT SLAVE LASH WHICH WILL LEAD TO POOR PERFORMANCE AND/OR ENGINE/ENGINE BRAKE DAMAGE.

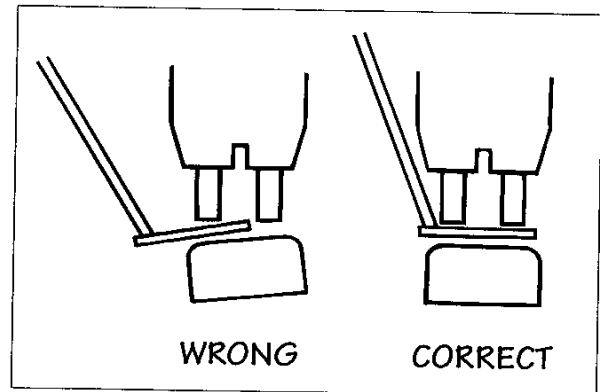

FIG. 1.5.28

Turn the adjusting screw clockwise until a slight drag is detected. Hold screw in this position and tighten locknut to 25 lb.-ft. (35 N•m).

# 1.6 Engine Brakes for Detroit Diesel Engines

## General Application Information

- 71A/92A (Fig. 1.6.1): Used on all 4, 6, 8, 12 and 16 cylinder engines whether naturally aspirated, turbocharged, TA or TTA engines

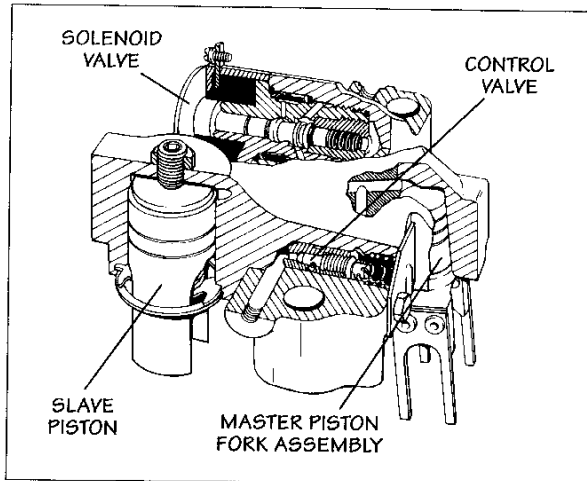

FIG. 1.6.1

- 53A (Fig. 1.6.2): Used on the following Detroit Diesel Engine Models: 3-53, 4-53, 6V-53, 8V-53

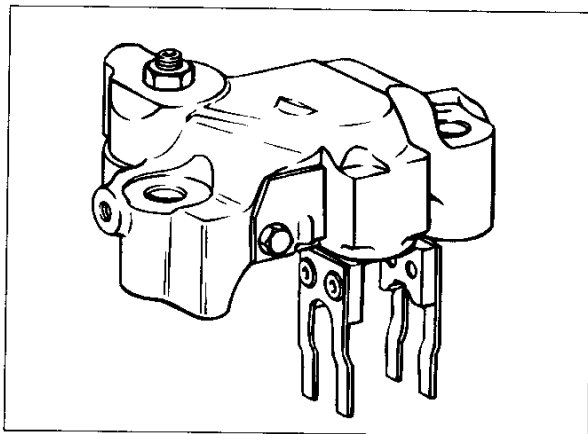

FIG. 1.6.2

## Adjustment of Engine Brake Slave Pistons

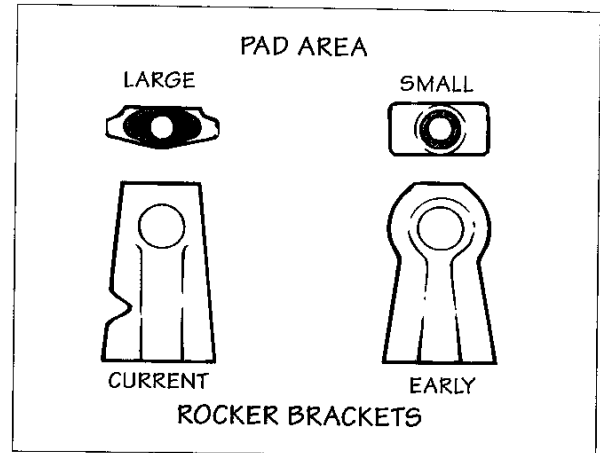
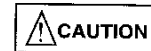

FIG. 1.6.3



FOLLOW ENGINE BRAKE ADJUSTMENT PROCEDURES CAREFULLY TO PREVENT ENGINE DAMAGE BY PISTON TO VALVE CONTACT. BEFORE MAKING SLAVE PISTON ADJUSTMENTS, MAKE SURE EXHAUST VALVES ARE CLOSED AND INJECTOR IS IN THE DELIVERY POSITION.

## Slave Piston Settings: Model 71/92A

Slave piston clearance must be set according to type of housing and rocker brackets. See Fig. 1.6.3. Refer to the following chart:

Housing/Bracket Type	Slave Piston Setting
Rocker Brackets with large pad area and 71A/92A engine brake housings	0.059"
All other combinations of brackets and housings	0.064"

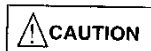

DO NOT USE THE 0.059" SETTING WITH THE FORMER DETROIT DIESEL ROCKER BRACKETS OR WITH THE EARLIER MODEL 71/92 ENGINE BRAKE. ENGINE OR ENGINE BRAKE FAILURES WILL RESULT. THOSE APPLICATIONS MUST CONTINUE TO USE THE 0.064 INCH SLAVE PISTON SETTING.

## Slave Piston Adjustment: Model 53A

The Model 53A slave piston adjustment is done by a turns method. See the Model 53A Installation Manual for procedures.

## Special Features/ Procedures

### Exhaust Valve Bridges

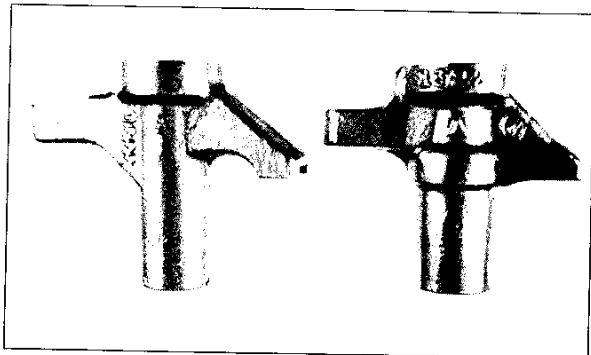

FIG. 1.6.4

The differences in the profile shape and the distance between valve stem contact points for Models 71A and 92A engine brake bridges can be seen in Fig. 1.6.4. Models 71A and 92A engine brake kits are identical except for bridge differences.

### DDEC Fuel Pipes

DDEC fuel pipes (Fig. 1.6.5) must be removed prior to engine brake housing removal. Check fuel pipes for damage especially at the fitting area and replace if necessary. Fuel pipes may be reused if in good condition

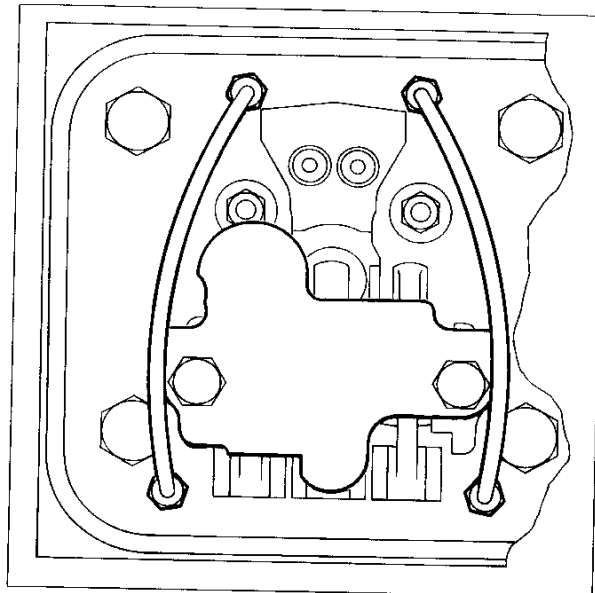

FIG. 1.6.5

### Fuel Pipes - Non DDEC Engines

The former flare type fuel pipes (Fig. 1.6.6) are not reusable. New O-ring style fuel pipes with attaching parts, must be installed in place of the flare type fuel pipes.

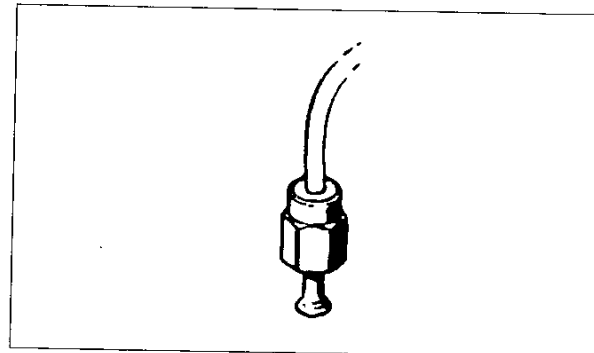

FIG. 1.6.6

# Fuel Pipe Installation

**NOTE:**

IT IS NECESSARY TO REMOVE INJECTORS WHICH HAVE BEEN OPERATED IN AN ENGINE BEFORE REPLACING FILTER CAPS.

## Non-DDEC Engines

Replace flare style fuel pipes with O-ring style fuel pipes. In the following instructions, numbers in parentheses refer to Fig. 1.6.7 and Fig. 1.6.8.

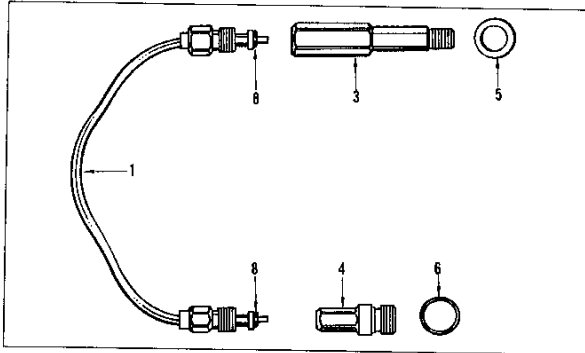

FIG. 1.6.7

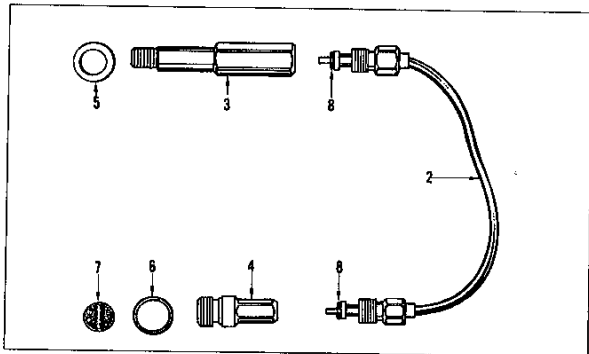

FIG. 1.6.8

1. Remove injectors according to instructions in the DDC engine service manual. Remove fuel connectors from cylinder head.
2. Install the new connectors (3) with washers (5) into the cylinder head (2 per cylinder) (see Fig. 1.6.9). Torque the connectors to 40 - 45 lb.-ft. (54 - 61 N•m).

FIG. 1.6.6

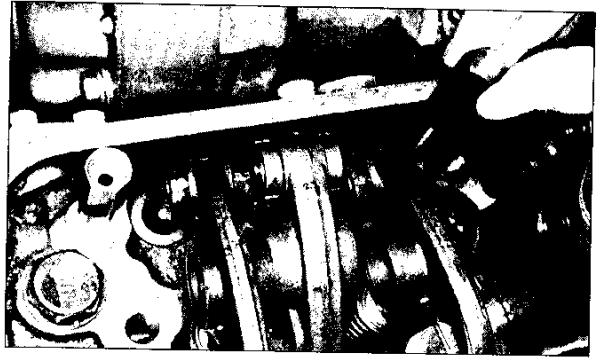

FIG. 1.6.9

3. Remove injector filter caps, washers, gaskets/fuel inlet filters.
4. Install the new filter (7) into the inlet port of the injector, grooved side up. The injector inlet port is located above the control rack (see Fig. 1.6.10).

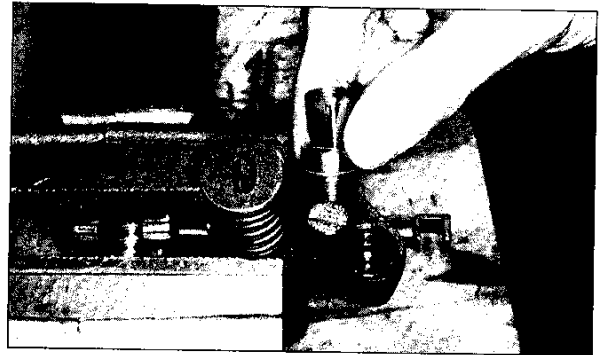

FIG. 1.6.10

5. Install the new fuel injector caps (4) and gaskets (6) into the inlet and return ports of the injector. Torque the caps to 60 - 70 lb.-ft. (82 - 95 N•m). Use a deep well socket and torque wrench.
6. Install and adjust the fuel injectors according to instructions in the DDC engine service manual.
7. Remove the protective caps from the fuel pipes.

**NOTE:**

THE O-RINGS (8) MUST BE INSTALLED ON THE FUEL PIPES.

- Lubricate the O-rings with clean lube oil and install the short (inlet) (2) and long (return) (1) fuel pipes.



SET THE PIPE ENDS INTO THE FITTINGS. HAND TIGHTEN THE FUEL PIPE NUTS. DO NOT BEND FUEL PIPES (SEE FIG 1.6.11). IF THE CONNECTIONS DO NOT FIT EASILY INTO THE FITTINGS OR, IF THERE IS INTERFERENCE WITH THE ENGINE BRAKE HOUSING, REPLACE THE FUEL PIPES. BENDING THE FUEL PIPES MAY RESULT IN FUEL LEAKAGE AND SEVERE ENGINE DAMAGE.

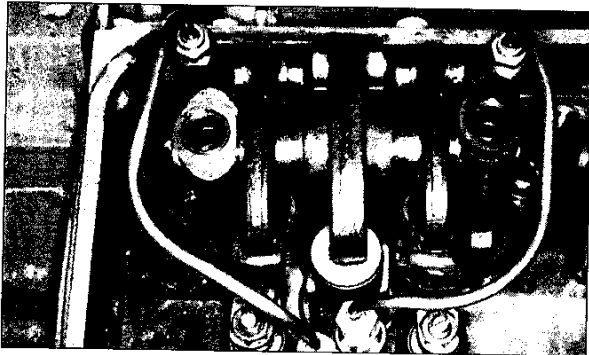

FIG. 1.6.11

- Torque the fuel pipe nuts to 160 - 200 lb.-in. (18 - 23 N•m) using a fuel pipe nut socket and torque wrench.

## Fast Idle Buffer Switch

This type of switch is installed to retain the fast idle feature and automatic engine brake operation.

Follow the standard buffer screw plunger and switch assembly installation.

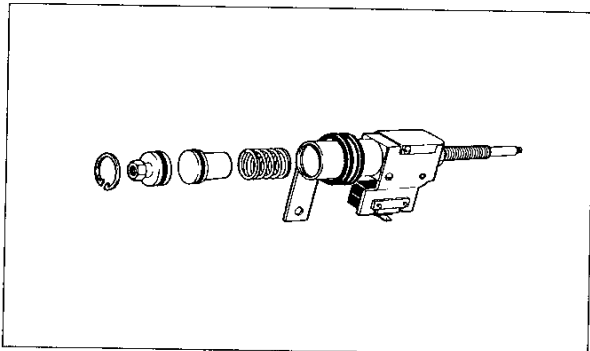

FIG. 1.6.12

- Attach the fast idle switch assembly to the buffer screw attaching nut.
- Adjust the switch bracket clamp to line up with the Detroit Diesel housing-to-blower bolt (Fig. 1.6.13).

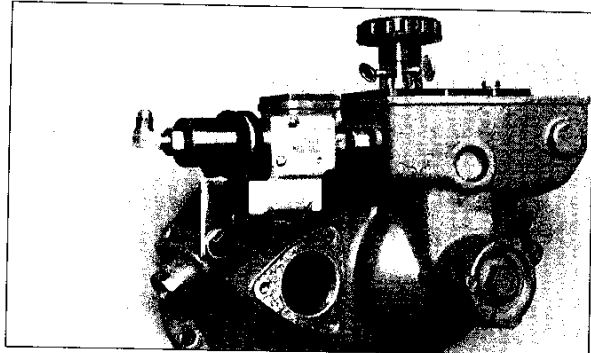

FIG. 1.6.13

- Remove the bolt and washer and secure the switch by placing the mounting bracket between the washer and bolt.
- Tighten the bolt and clamp.
- Install the air tube elbow into the inlet plug and attach the air tube between the elbow and the fast idle limiting air cylinder on top of the governor housing.

With the fast idle buffer switch properly installed, the engine brake will operate only during deceleration and will automatically shut off when fast idle activation occurs.

## Oil Connectors

Poor performance problems may be caused by improperly installed or broken oil connectors. Pay particular attention to this area during troubleshooting.

- Reposition the seal ring in the head of the oil connector to make sure it fits into the recessed hex head of the connector screw (Fig. 1.6.14).

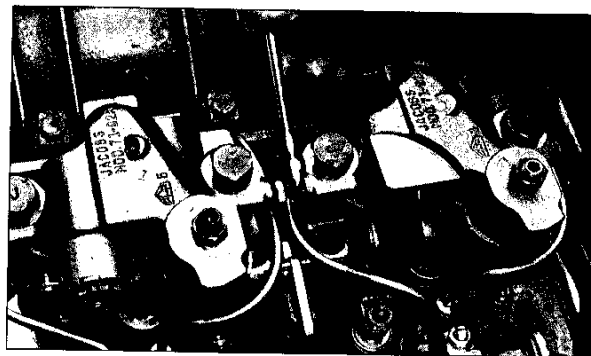

FIG. 1.6.14



4. Hold the oil connector in this position and carefully lock the lock nut. Use two short open end wrenches (Fig. 1.6.15). Remember, too much torque on these connectors will cause them to crack.

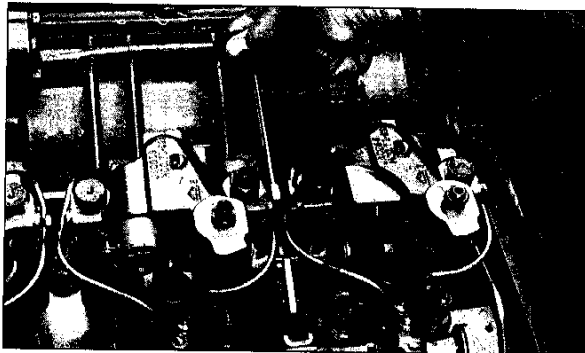

FIG. 1.6.15

### Clevis for Injector Rocker Lever

In 1978, Detroit Diesel began using a larger clevis for the injector rocker lever. This clevis and the standard Jacobs fork assembly made an overall height greater than acceptable. Interference with the bottom of the engine brake housing could be damaging and an engine brake power loss could result.

When installing an older engine brake on a new engine or using older spare parts, special attention must be given in this area. The current fork assembly, P/N 003337, and spring, P/N 009505, can be used on both the high and standard clevises. It is **strongly recommended** that old housings be updated to the P/N 003337 fork and P/N 009505 spring combination.

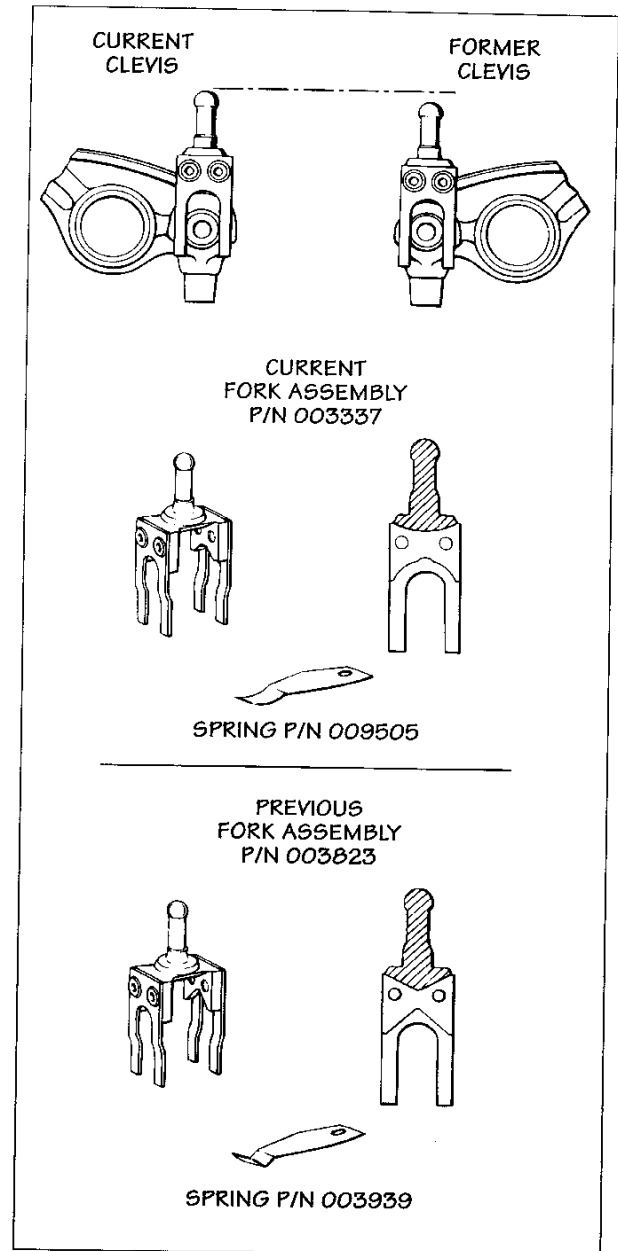

FIG. 1.6.16

## Two-Valve Head

Detroit Diesel also makes a two-valve cylinder head design. For this design, the Jacobs exhaust bridge is replaced with a Jacobs valve stem cap.

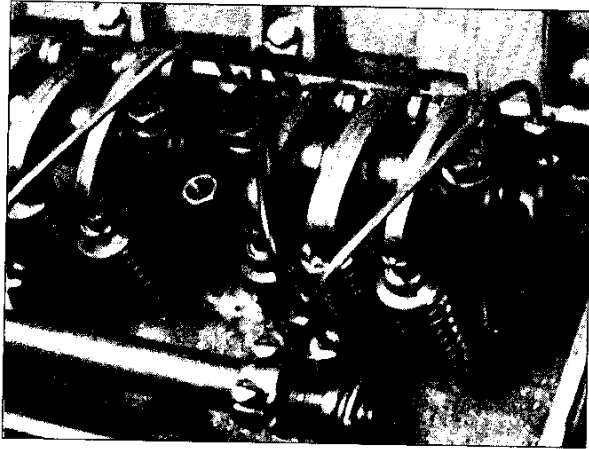

FIG. 1.6.17

1. On engines equipped with high mount injector clamps, remove the clamp by removing the bolt and special washer. Replace with a Jacobs high mount clamp and use the same washer and bolt (Fig. 1.6.18). Tighten the bolt to 25 lb.-ft. (35 N·m). The Jacobs clamp can be identified by a small milled section on one side. This provides clearance for the exhaust valve stem cap.

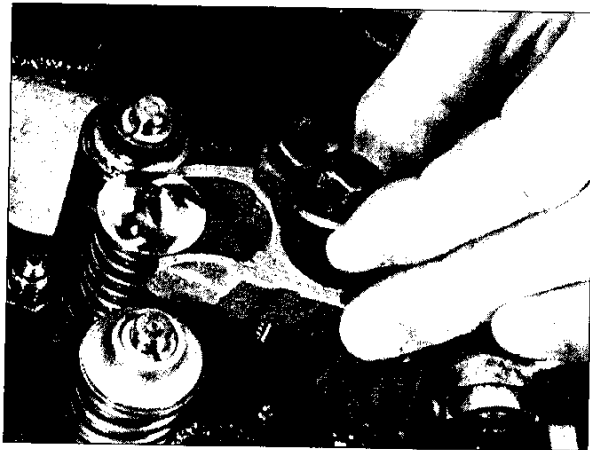

FIG. 1.6.18

2. Install Jacobs valve stem caps on right-hand exhaust valves (one per cylinder) (Fig. 1.6.19). Press caps firmly over valve springs. Hexagon cover studs must be removed if located near this valve.

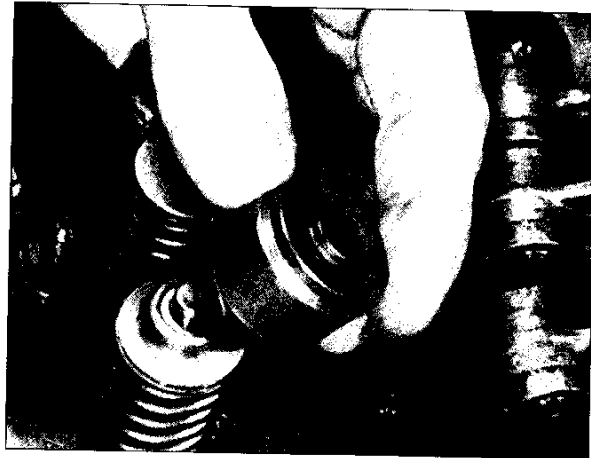

FIG. 1.6.19

3. Using the Jacobs clamping tool, back off the thumb screw. Install the tool squarely over the valve stem cap with its feet under the exposed coil of the valve spring (Fig. 1.6.20). Tighten the thumb screw to seat the cap. Remove the tool.

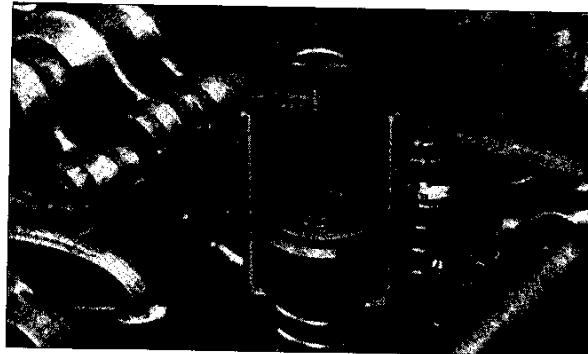

FIG. 1.6.20

# Models 760/760A/765 Engine Brakes

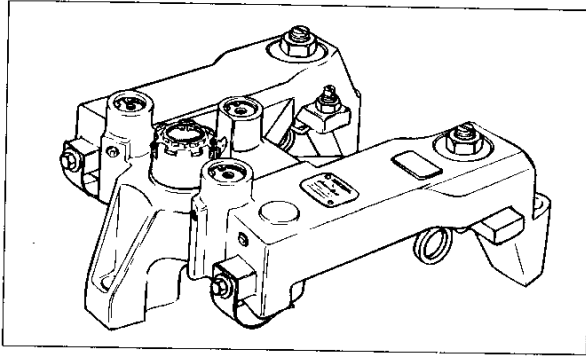

FIG. 1.6.21

## Engine Identification

Engine model identification is on the name tag located on the side of the valve cover and stamped on the cylinder block beneath the intake manifold.

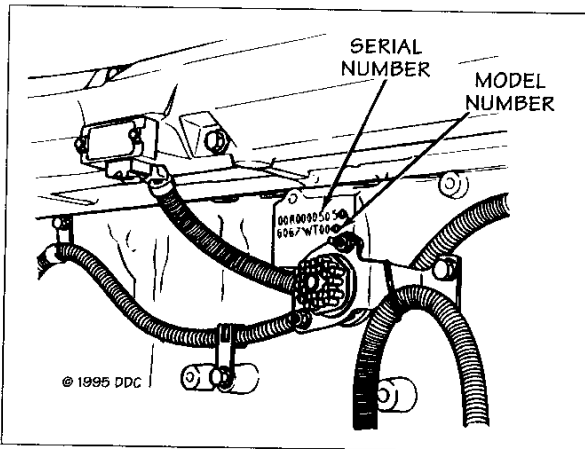

FIG. 1.6.22

A "G" is the model number indicates 12.7 liter displacement; a "W" indicates 11.1 liter displacement. See the typical model number below:

6 0 6 7 **G** U 6 0

Displacement

G = 12.7

W = 11.1

Model Year

40 = Pre 1991

60 = 1991 and later

28 = 1991 and later (Coach)

## Application Information

Model No.	Model Year	Application	Jake Brake Model
6067WU40	Pre '91	Truck	760A
6067GU40	Pre '91	Truck	760A
6067WU60	'91 & later	Truck	760A
6067GU60	'91 & later	Truck	765
6067GU28	'91 & later	Coach	765
6067GU91	'91 & later	Military	765
6067WK60	'91 & later	Truck	760A
6067GK60	'91 & later	Truck	765
6067GK28	'91 & later	Coach	765

## Slave Piston Adjustment

Models 760/760A/765 require a single-blade feeler gauge for slave piston adjustment. For correct adjustment procedures, clearance settings and feeler gauge part numbers, see Jacobs installation and parts manuals and service publications.

## Housing Mounting Bolts

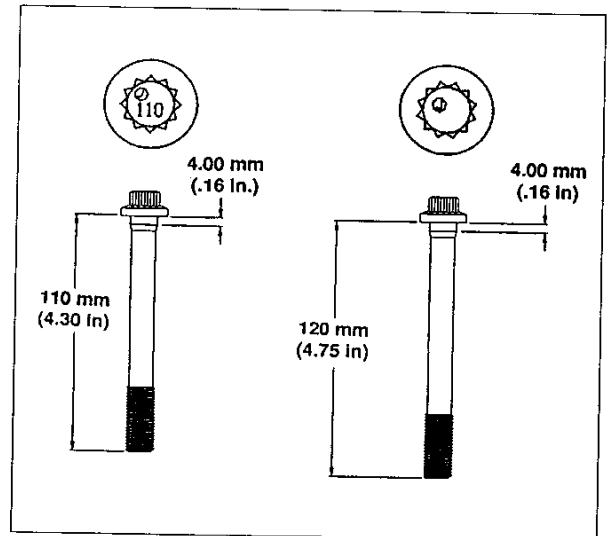

FIG. 1.6.23



IT IS IMPERATIVE THAT THE CORRECT JACOBS BOLTS BE USED FOR THE ENGINE BRAKE HOUSING BEING INSTALLED. INSTALLATION OF INCORRECT BOLTS WILL RESULT IN ENGINE AND ENGINE BRAKE DAMAGE.

Model 760: Use one 120 mm bolt, P/N 012995, and two 110 mm bolts, P/N 016345, for each housing.

Models 760A and 765: Use three 110 mm bolts, P/N 016345, for each housing.

Follow the instructions in the Installation Manual, P/N 014328, for correct application and torque information.

The Detroit Diesel rocker arm shaft bolt used on Series 60 engines has a shoulder that is much longer than the Jacobs bolt and has the logo (spinning arrows) and vendor ID (F-C) on its head (see Fig. 1.6.24). This bolt MUST NOT be used for the engine brake housing hold down.

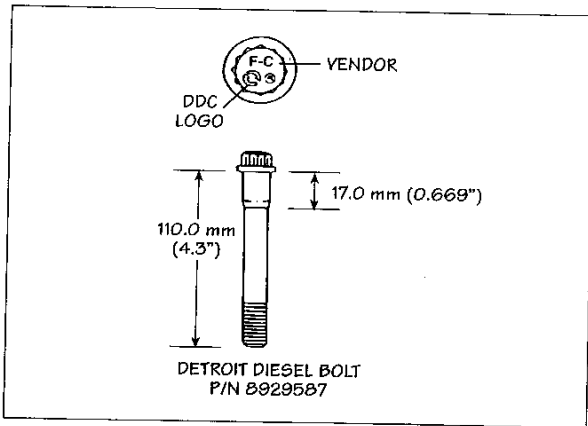
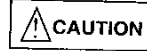

FIG. 1.6.24



IF THE DETROIT DIESEL BOLT IS MISTAKENLY USED FOR ENGINE BRAKE HOLD DOWN, THE LONGER SHOULDER ON THE BOLT WILL RESTRICT OIL SUPPLY TO THE HOUSING AND PREVENT PROPER BRAKE OPERATION.

## Ball Check Valve (Model 760 Only)

Remove the plug to remove the ball check valve and spring. Inspect parts for wear or damage and replace, if necessary. Reinstall the parts in the proper sequence (see Fig. 1.6.25).

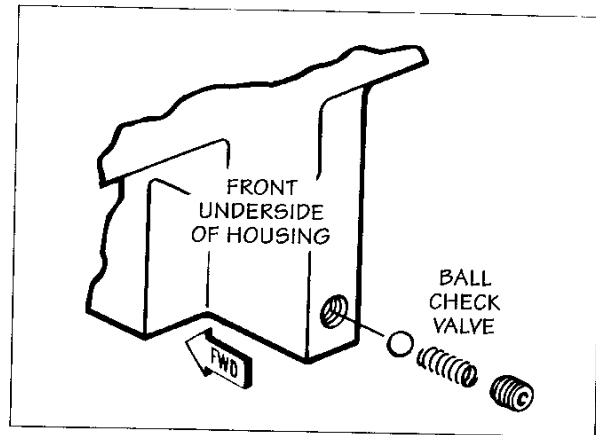

FIG. 1.6.25

# 1.7 Engine Brakes for Mack Engines

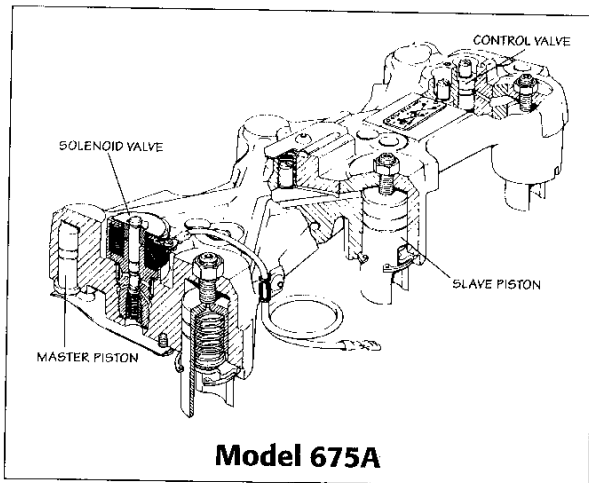

FIG. 1.7.1

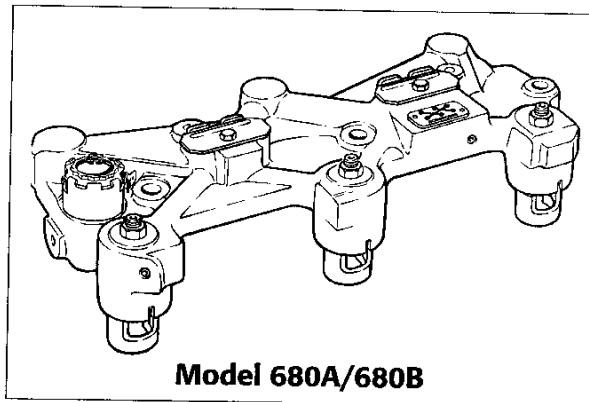

FIG. 1.7.2

## General Application Information

The Model 680B Jake Brake engine retarder is designed and approved for use on Mack E7 engines.

The Model 680A Jake Brake engine retarder is designed and approved for use on Mack E6 engines with four-valve cylinder head configuration.

The Model 675A Jake Brake engine retarder is designed and approved for use on all Mack 6 cylinder 672 and 711 CID automotive engines: E6, EC6, EM6 and EMC6. The Model 675A replaces the Model 675 in the Jacobs engine brake product line.

## Special Features/ Procedures

### Valve Stem Caps: Models 675 and 675A

NOTE:

LATER PRODUCTION ENGINES HAVE 0.345" (11.1 MM) DIAMETER VALVE STEMS. USE JACOBS VALVE STEM CAP, P/N 009263, ON THESE ENGINES. MACK ENGINES WITH SERIAL NUMBERS BELOW 9V6755 CAN HAVE LARGER DIAMETER EXHAUST VALVE STEMS, 0.486" (12.3 MM). JACOBS VALVE STEM CAP, P/N 002032, MUST BE USED ON THESE EARLIER ENGINES.

Place the Jacobs valve stem caps on top of each exhaust valve.

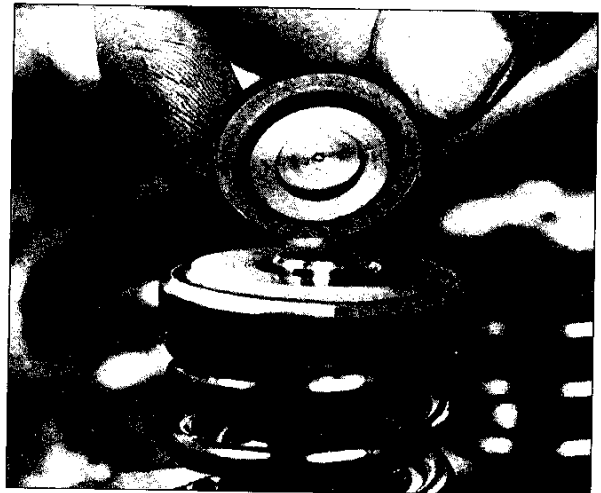

# Slave Piston Adjusting Screw

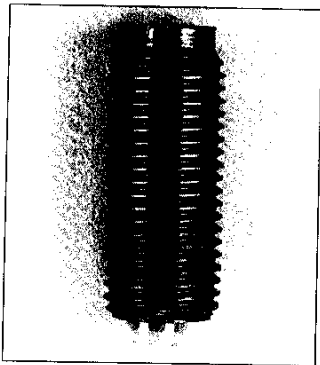

FIG. 1.7.4

**NOTE:**

EARLY MODEL 675A PRODUCTION HOUSINGS (S/N B-370476 AND LOWER) AND ALL 675 HOUSINGS USE SOLID ADJUSTING SCREWS AND SLAVE PISTONS WITH NO HOLES.

MODEL 675A HOUSINGS (S/N B-370477 AND GREATER) HAVE ADJUSTING SCREWS WITH SPRING-LOADED PLUNGERS AND SLAVE PISTONS WITH HOLES.

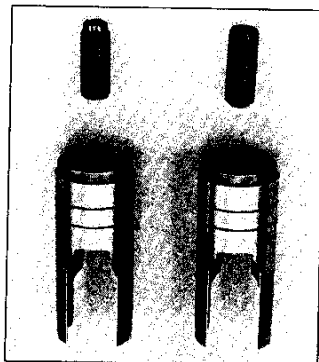

FIG. 1.7.5



ADJUSTING SCREWS AND SLAVE PISTONS MUST NOT BE INTERMIXED.

**NOTE:**

THE SPRING-LOADED PLUNGER IS DESIGNED TO PREVENT SLAVE PISTON OVERTRAVEL IN THE EVENT OF EXCESSIVE ENGINE OIL PRESSURE OR RESTRICTED SLAVE PISTON MOVEMENT.

Inspect the plastic plunger in the Model 675 adjusting screw. It should move freely in the screw. Clean or replace the entire screw if the plunger does not move freely.

## Oil Supply Screw: Models 675 and 675A

**NOTE:**

ENGINES MANUFACTURED PRIOR TO MARCH, 1986, HAVE A 1/4-20 THREADED HOLE FOR THE ROCKER SHAFT LOCKING SCREWS (SEE FIG. 1.7.6). THESE ENGINES REQUIRE JACOBS OIL SUPPLY SCREW, P/N 014043, AND WASHER, P/N 014104.

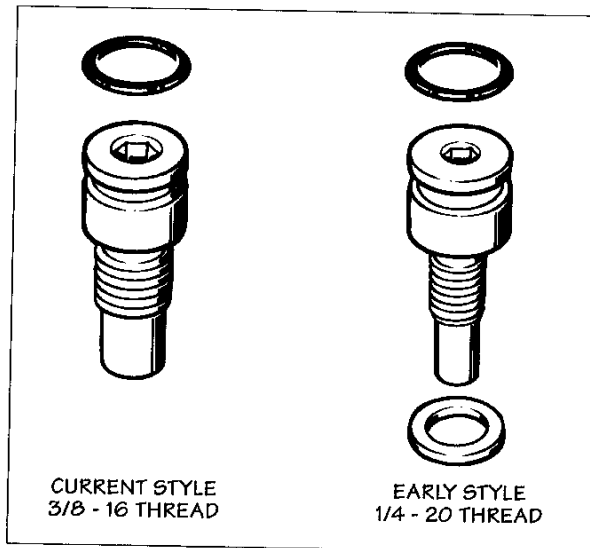

FIG. 1.7.6

## Slave Piston Adjustment

Models 675 and 675A require a fork-type feeler gauge for slave piston to valve cap clearance setting. This is required to be sure the valve stem cap is level with the slave piston when adjustment is made.

For correct adjustment procedures, clearance settings and feeler gauge part numbers, see Jacobs' installation and parts manuals and service publications.

## Exhaust Valve Yoke Replacement

Early Jacobs Model 680A/680B exhaust valve yokes have SAE threads. Current production yokes have metric threads. Be sure to use the correct screws and nuts for replacement parts.

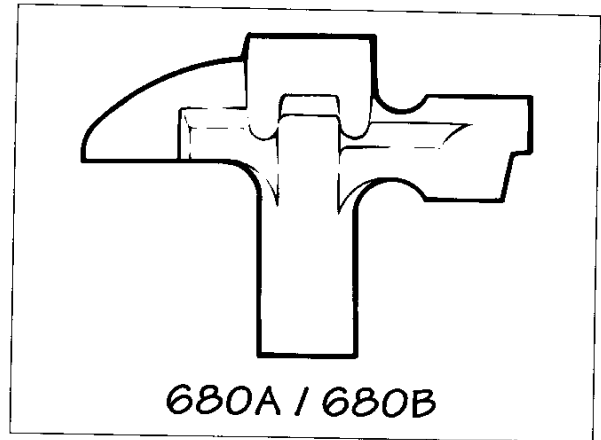

FIG. 1.7.7

# Section 2: Preventive Maintenance

## Introduction

The Jacobs Engine Brake is typically a trouble-free device. However, inspections are necessary and some maintenance is required. The mileage and hours intervals presented here are intended as a guide for establishing a routine of Jake Brake inspection and maintenance in conjunction with scheduled engine maintenance.

Severe driving conditions, types of roads and driving areas will affect the length of time between scheduled maintenance. Engines exposed to severe applications and operating environments may require more frequent preventive maintenance, thereby altering engine retarder maintenance intervals as well.

The Recommended Preventive Maintenance Schedule shown below is applicable to all engine brake models.

## Recommended Preventive Maintenance Schedule

Part	12 Months 100,000 Miles 3,000 Hours	36 Months 300,000 Miles 9,000 Hours	60 Months 500,000 Miles 15,000 Hours
Wiring/Terminal Connections	I	I	I
Clutch/Throttle/Buffer	A	A/R	A/R
Safety Valve Screw Assembly	I	I	R
Solenoid Valves		I	R
Reset/Auto-Lash <sup>®</sup> Assembly		I	I/R
Crosshead/Bridges/Valve Stem Caps		I	I/R
Injector/Exhaust Rocker Arm Screws	I	I	I/R
Master Piston/Fork Assembly		I	I/R
Slave Pistons			I
External Hose Assembly	I	I/R	I/R
Housings		I	I
Fuel Pipes	I	I/R	I/R
Hold-down Bolts		I	R
Accumulator Springs*		R	
Solenoid Harness*		R	I/R
Solenoid Seal Rings*		R	I/R
Control Valve Springs*		R	I/R
Control Valves*		R	I/R
Oil Seal Rings*	I	R	I/R
Master Piston Return Springs*	I	R	I
Terminal Lead Out*	I	R	I
Crosshead Pin Assembly*	I	R	I

I = inspect/correct as required      A = Adjust      R = Replace

\* contained in tune-up kits



## 2.1 Inspection Criteria

### Safety Valve Screw Assembly Inspection



FIG. 2.1.1

1. Check the plunger in the safety valve screw. The plunger should protrude from the bottom of the screw, have light spring pressure apparent when depressed, and should move freely.
2. Inspect the area of the plunger which contacts the slave piston. The area should be flat and smooth.

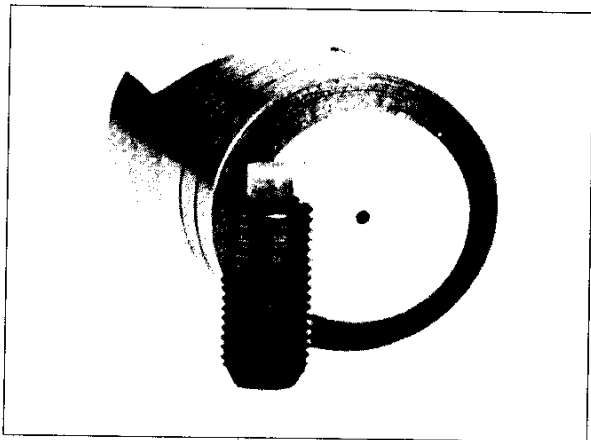

FIG. 2.1.2

3. Clean in an approved cleaning solvent and apply clean engine oil at reinstallation.

4. Ensure that the hole in the slave piston is visible through the threaded screw hole in the housing and aligns with the plunger.

NOTE:

THE SCREW ASSEMBLY CANNOT BE  
DISASSEMBLED IN THE FIELD.

### Exhaust Crosshead/ Bridge or Valve Stem Cap Inspection

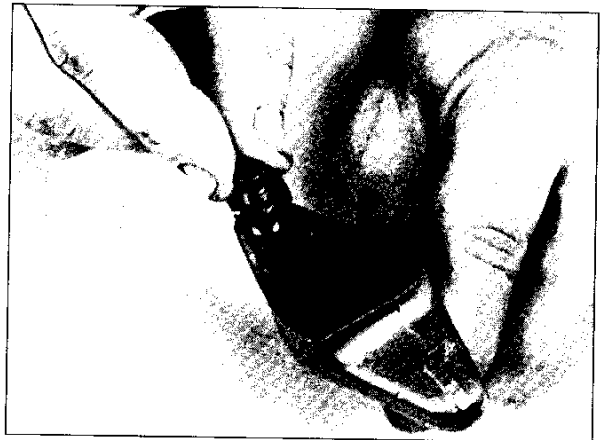

FIG. 2.1.3

1. Check the hardened surface on the Jacobs exhaust crosshead/bridge/valve stem cap for excessive wear at either the point of rocker lever contact or slave piston contact. If the wear is 0.004" deep or more, the crosshead/bridge/cap must be replaced.

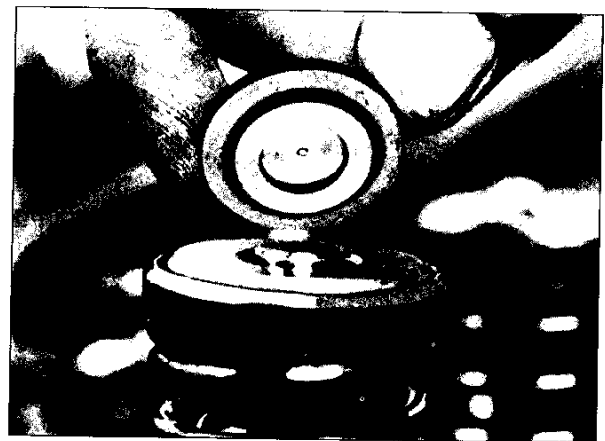

FIG. 2.1.4

2. Inspect the area of the valve stem cap that surrounds the valve stem for cracks or excessive wear. If any of these defects are visible, replace the valve stem cap.
3. Check the crosshead/bridge bore and valve stem contact areas. Ensure that they comply with applicable engine manufacturer's service parameters.

## Master Piston Inspection

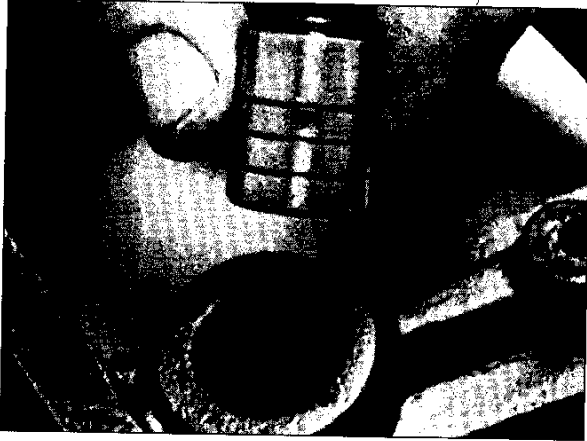

FIG. 2.1.5

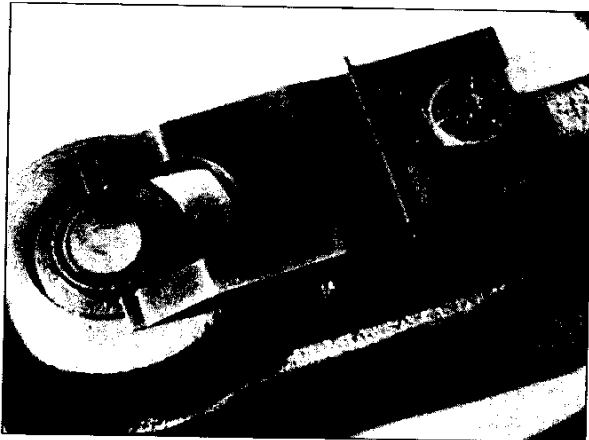

FIG. 2.1.6

1. Remove the master piston from the bore using needle nose pliers. The master piston should move smoothly in the bore. If binding occurs, check for burrs or contaminants in the oil. The sides of the master piston may show some polish but should not show extensive scoring, grooving or wear.
2. Inspect the hard face surface. Pitted, chipped, cracked or galled pistons should be replaced.
3. Coat the master piston with clean engine oil before reinstalling.

## Injector/Exhaust Rocker Arm Adjusting Screw Inspection

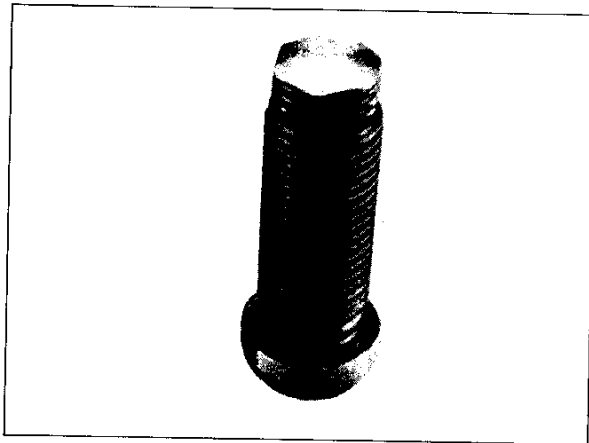

FIG. 2.1.7

1. Check both the hex head and spherical (ball) end surface of the adjusting screws. The spherical end should be checked for proper contour and smooth appearance.
2. Check the hex head for excessive wear. If a depression, 0.005" or deeper, is found in the top of the hex head, or if the pattern of "wipe" extends beyond the hex, replace the adjusting screw. Also replace the companion master piston.

## Slave Piston Inspection

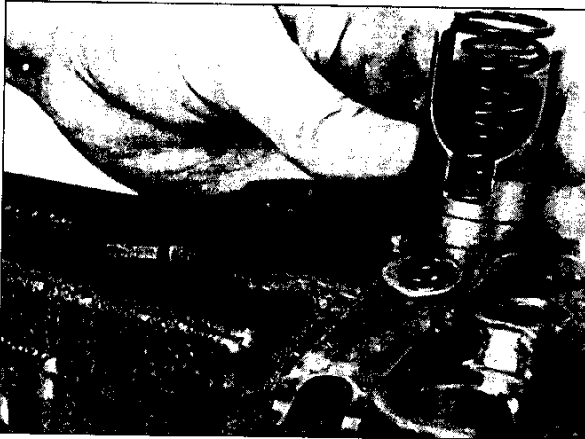

FIG. 2.1.8



WEAR SAFETY GLASSES. FOLLOW INSTRUCTIONS CAREFULLY THE SLAVE PISTON IS RETAINED BY A SPRING UNDER HEAVY COMPRESSION. IF INSTRUCTIONS ARE NOT FOLLOWED AND PROPER TOOLS ARE NOT USED, THE SPRING COULD BE DISCHARGED WITH ENOUGH FORCE TO CAUSE PERSONAL INJURY.

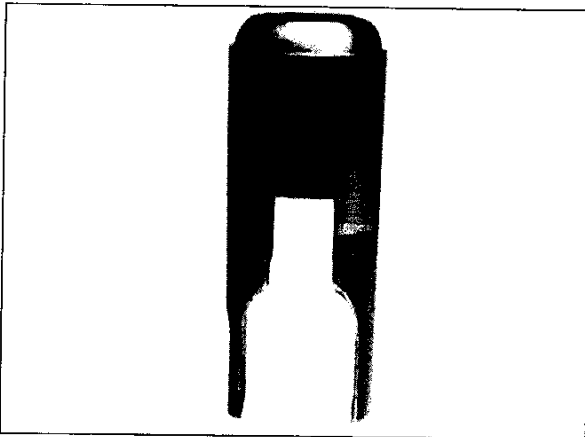

FIG. 2.1.9



FIG. 2.1.10

1. Check for nicks or burrs that could cause binding. Clean the piston in an approved cleaning solvent. Replace the piston if the ground surface on the outside diameter looks questionable.
2. Run a small wire through the bleed holes in the single-valve and Caterpillar and Mack engine brakes.

## Crosshead Screw and Pin Assembly Inspection (Single-valve Opening)

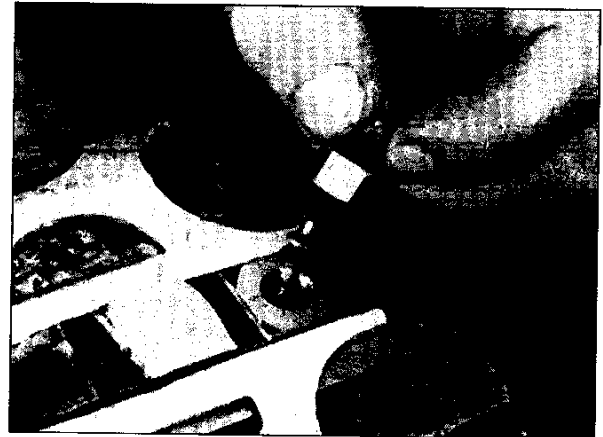

FIG. 2.1.11

Inspect the crosshead pin assembly for the following:

1. Snap ring or grip ring present.
2. Cracks in screw body.
3. Wear on pin where valve stem is contacted.
4. Wear on screw where valve stem is contacted.
5. Bent pin.
6. Cracks in pin.

If any of these conditions are found, the pin assembly must be replaced. Also examine the slave piston for signs of wear at the contact point with the pin assembly.

## Slave Piston Adjusting Screws Inspection

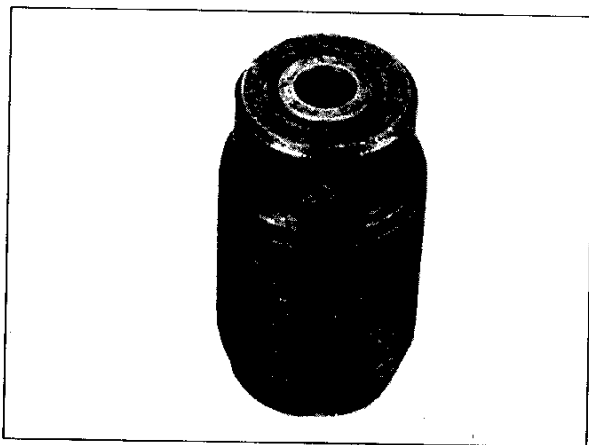

FIG. 2.1.12

Different types of slave piston adjusting screws are used in the various engine brake model housings. These parts are very similar in appearance but must only be used in their designated housings. Refer to current parts and service publications for correct applications.

Part numbers for the Auto-Lash®, Power-Lash® and reset screws are located on the top of the screw body. The screw body has a 1/2 x 20 thread.

The safety valve has a plunger protruding from the bottom of the screw. The screw body has a 3/8 x 24 thread.

1. Inspect Auto-Lash® for proper plunger protrusion. Inspect for strong spring resistance when depressing plunger. Look for cracks in the screw body and replace the Auto-Lash if any cracks are found.

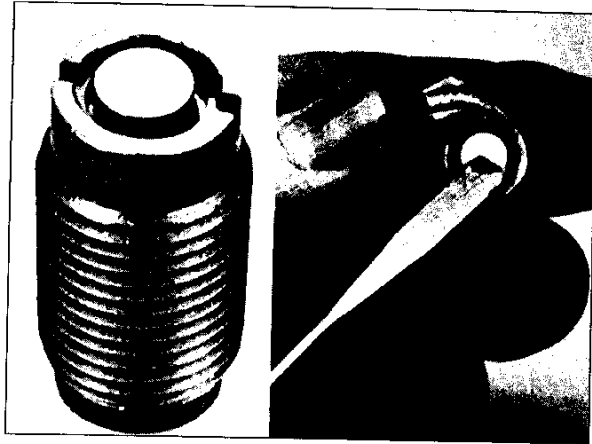

FIG. 2.1.13

2. Inspect the slave piston adjusting screw. The plunger should have light spring pressure apparent when depressed and should move freely. Be sure the retaining ring is fully engaged in its groove.
3. Clean in an approved cleaning solvent. Replace the entire screw if necessary.



MAKE NO ATTEMPT TO READJUST OR TAMPER WITH THE ADJUSTING SCREW. THIS COULD RESULT IN ENGINE DAMAGE.

## Control Valve Inspection

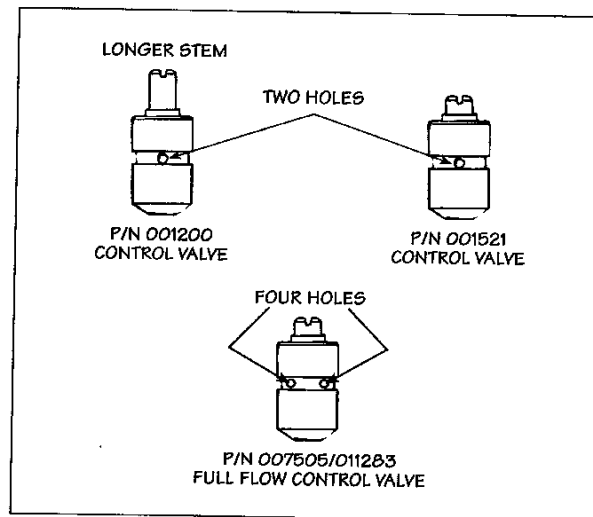

FIG. 2.1.14

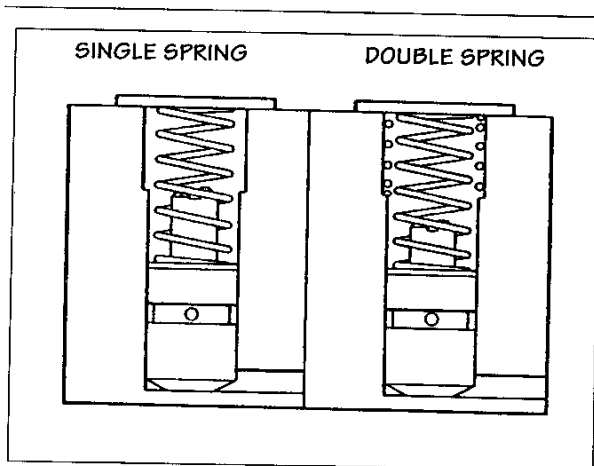

FIG. 2.1.15

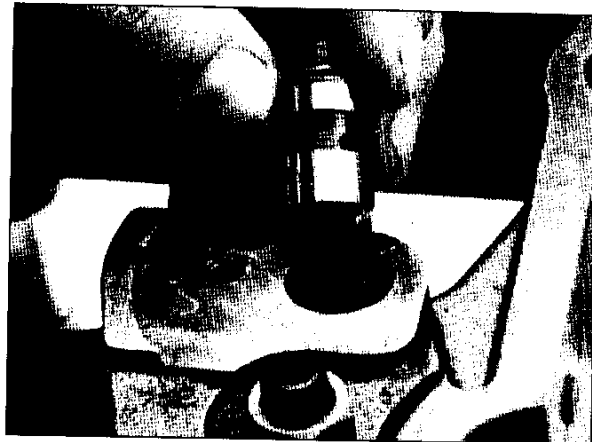

FIG. 2.1.16

1. Check to see that control valves move freely in their bores.
2. Wash control valves with an approved cleaning solvent. Insert a wire in the entrance hole in the base of the control valve to make sure the check ball is free and has light spring pressure.
3. Dip the control valves in clean lube oil.
4. Hold the valve at the top of its bore and release. When released, the valve should slowly settle under its own weight to the bore bottom. If binding occurs or the check ball is stuck, replace the control valve.